

44th Annual Regional Convention
Region III

Past, Present and Future of Geospatial Information Systems

Challenges of Modern Geodetic Engineers

Engr. Oliver T. Macapinlac MSc.
Asst. Professor DGE UP, Diliman

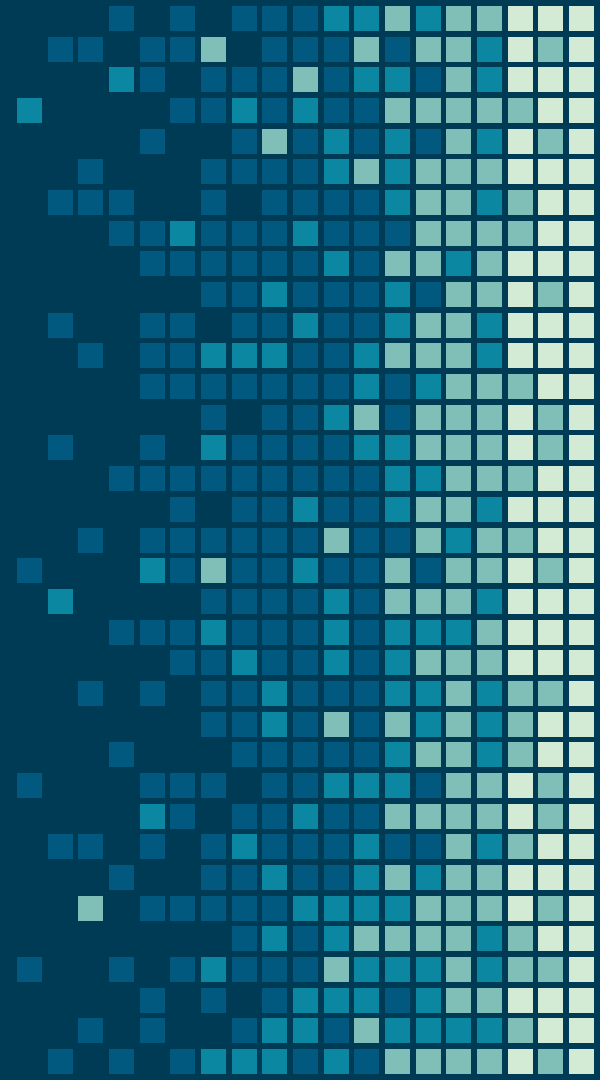



Outline of Presentation

- Context and background of the talk
- Historical highlights: from past to present
- Future vision and directions
- Where are we now? Where are we headed?
- Academic curriculum of GE
 - Anticipating the trends
- Take Home Message



- Context and background of the talk
- Historical highlights: from past to present
- Future vision and directions
- Where are we now? Where are we headed?
- Academic curriculum of GE
 - Anticipating the trends
- Take Home Message

Why Geospatial Information Systems?

Why *not* Geographic Information
Systems (GIS)

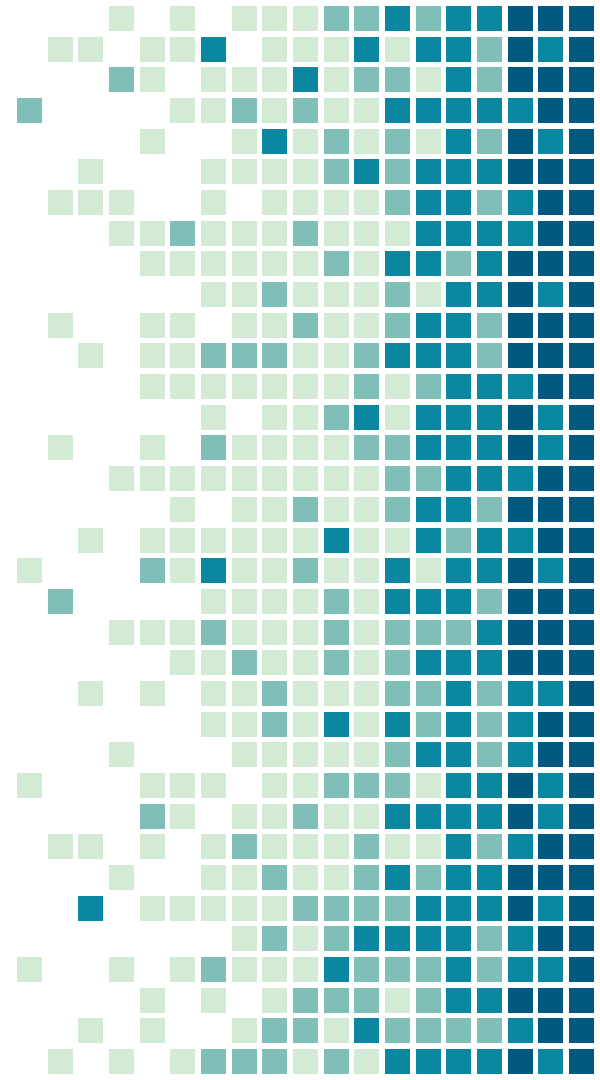

Spatial Information Systems

- **Spatial**– 80% of data collected is associated with some *location* in space
- **Information** - *attributes*, or the characteristics (data), can be used to provide further insight into a given location
- **System** – a seamless operation linking the *information* to the *location*– which requires hardware, networks, software, data, and operational procedures.



Geographic Information Systems (GIS)

- A spatial information systems with explicit definition of a geographic reference system (GRS)
 - PRS 92
 - WGS 84
 - Google Mercator, etc...



Why not GIS?

- We are still including fields in engineering that are not explicitly geo-referenced, example:
 - Spatial 2D/3D models
 - BIM – Building Information Modeling

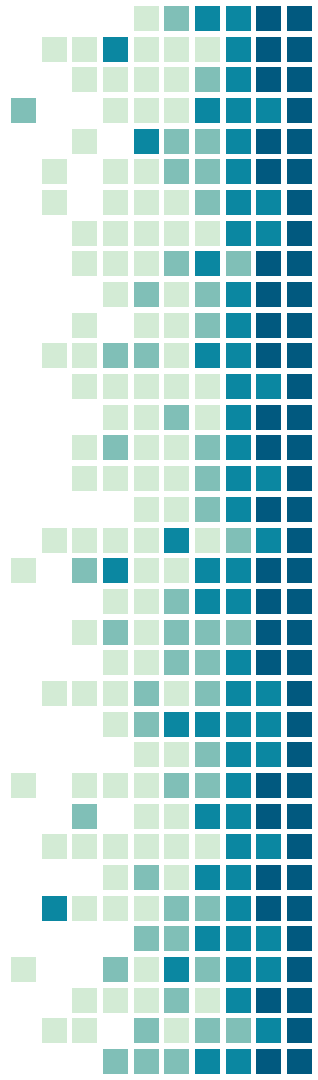
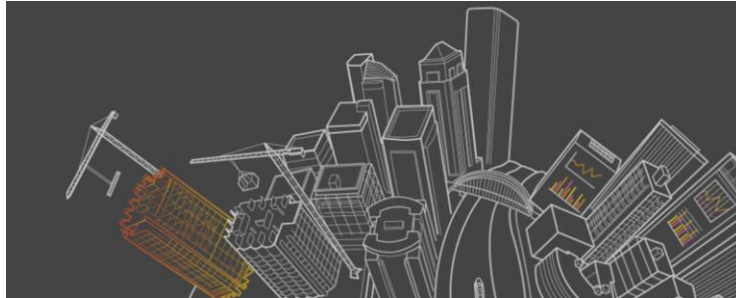

Cadastral lots



Water Features

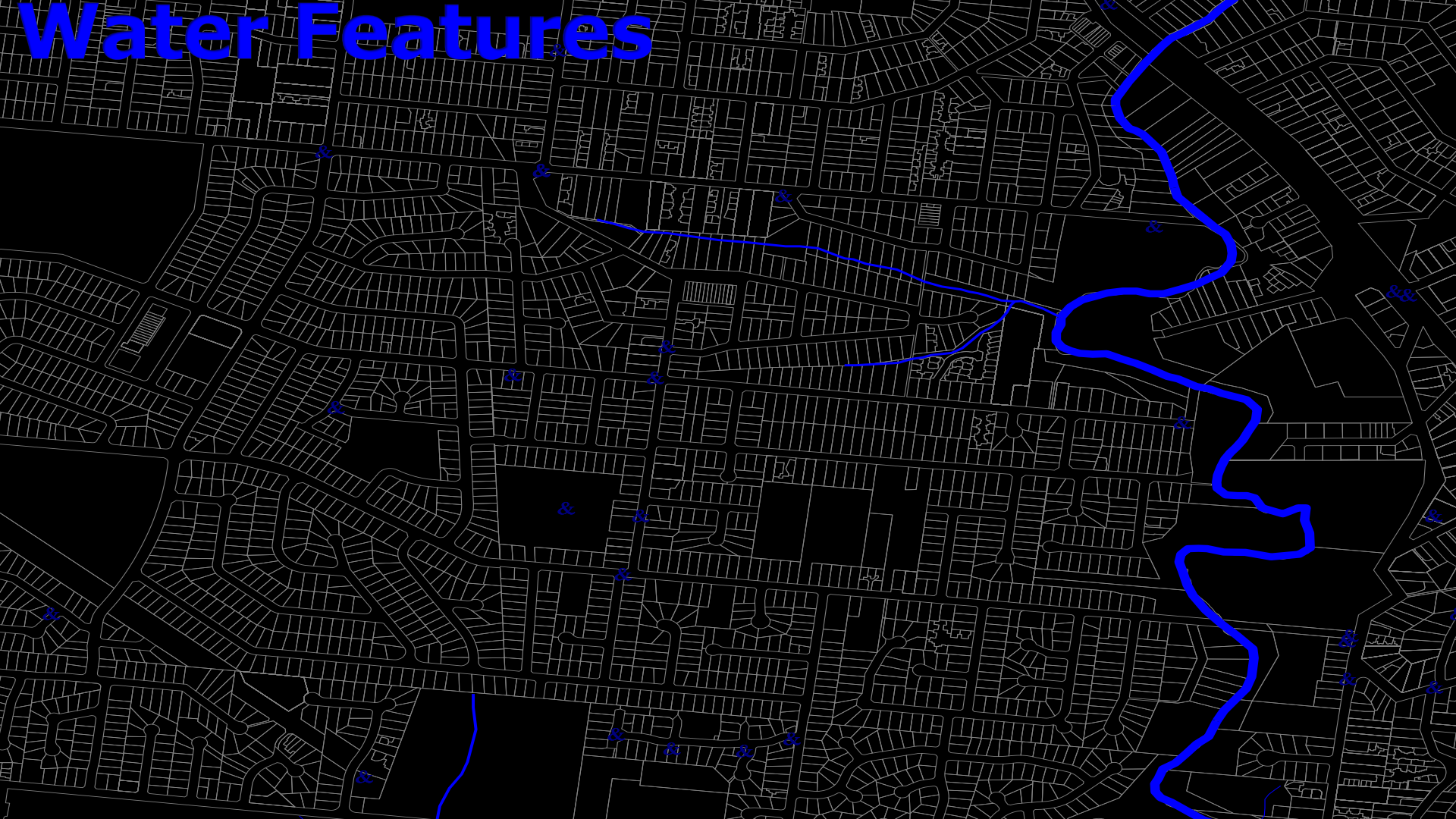

Elevation Data



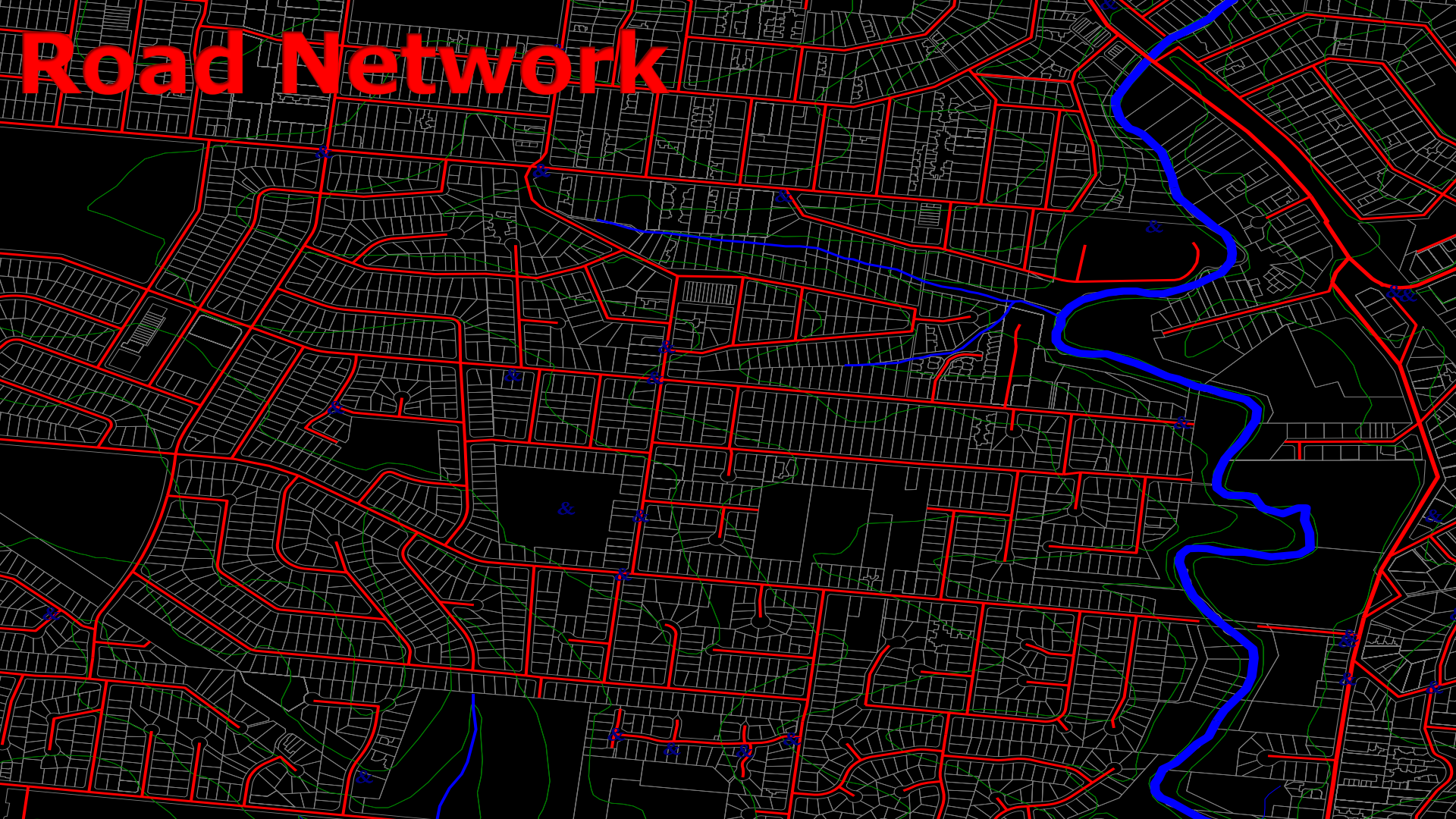

Road Network

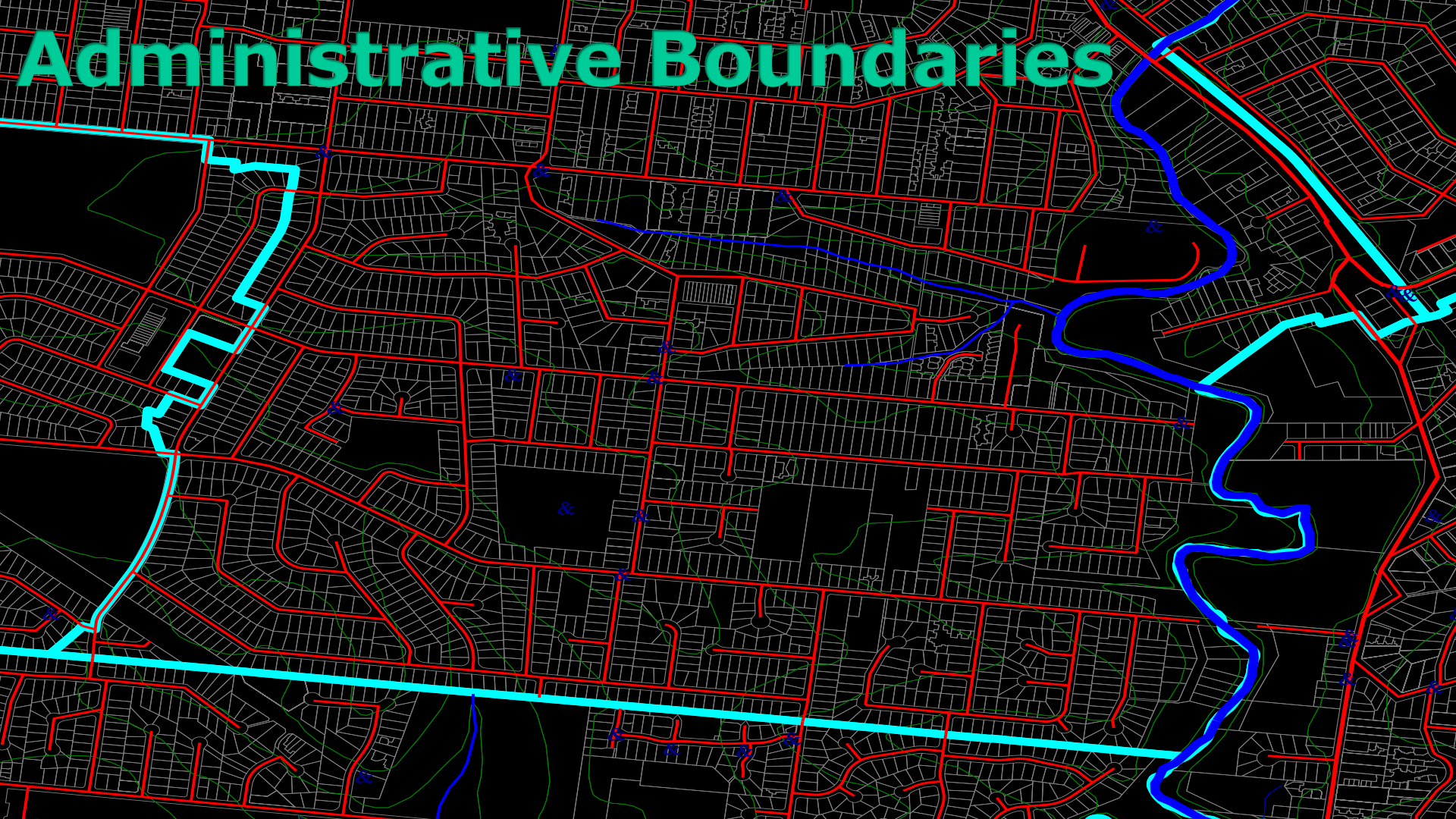

Administrative Boundaries

Addresses



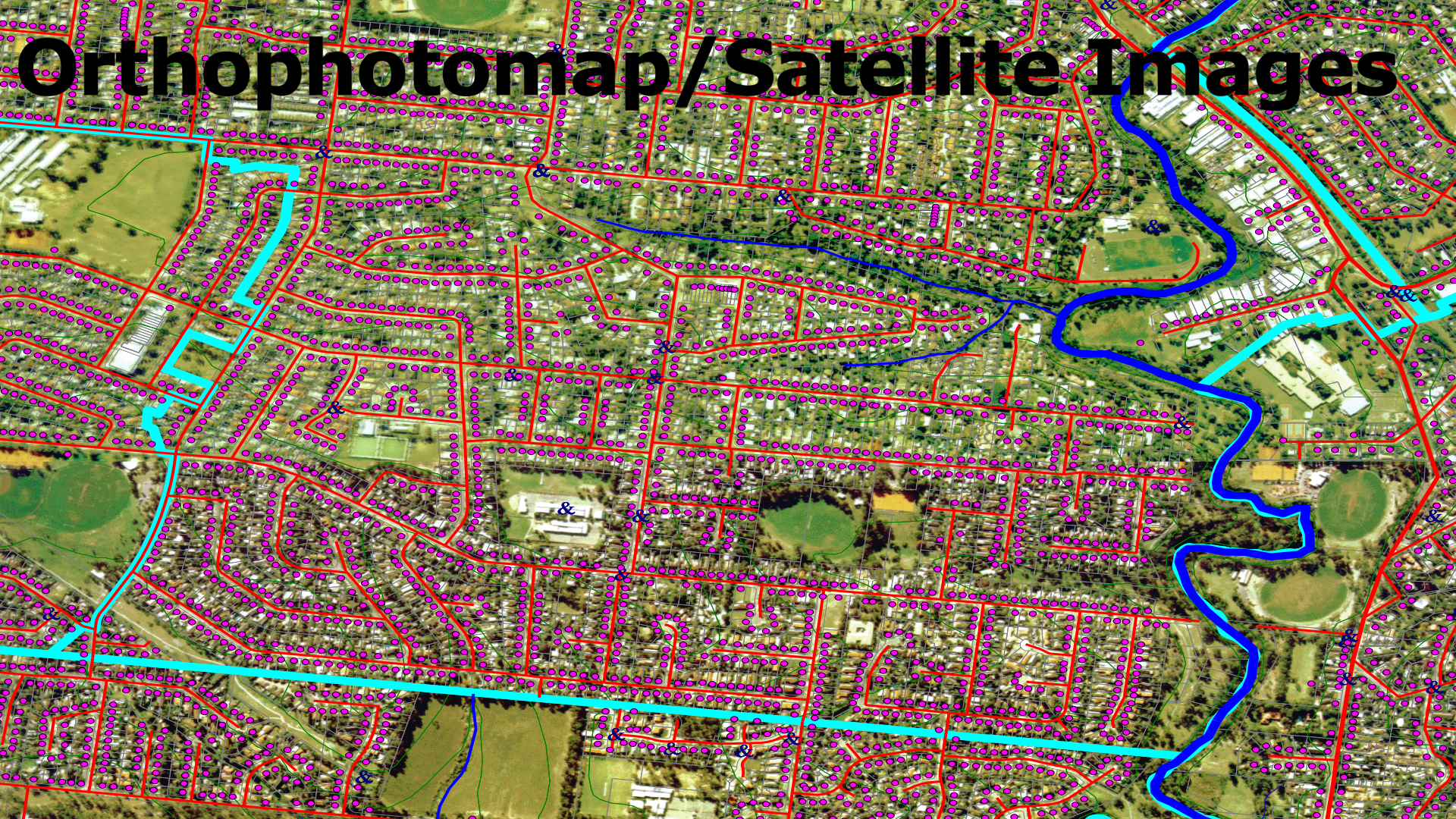

Orthophotomap/Satellite Images

Geomatics

- An umbrella field that encompasses the *acquisition, modeling, study* and *management* of spatial data.
- Technology:
 - uses global, maritime, aerial and satellite based sensors to obtain data.
 - transforms the data obtained from different resources into selected information systems



“ Advances that influenced geomatics:

- **Computer** technology, **software** engineering, and computer **science**.
- **Space sensing** technologies
 - Remote Sensing
 - Positional Satellite (e.g. GNSS)

Several universities have gone so far as to replace the names of their survey departments with **geomatics or geomatic engineering**.

Major Fields in Geomatics:

- Mapping
- Navigation
- Geodesy
- Remote Sensing
- Global Positioning System
- Photogrammetry
- Airborne/Terrestrial Laser Scanning
- Geospatial Information Systems
- Digital Terrain Modeling
- Hydrography



More options means more roles for Geodetic Engineers

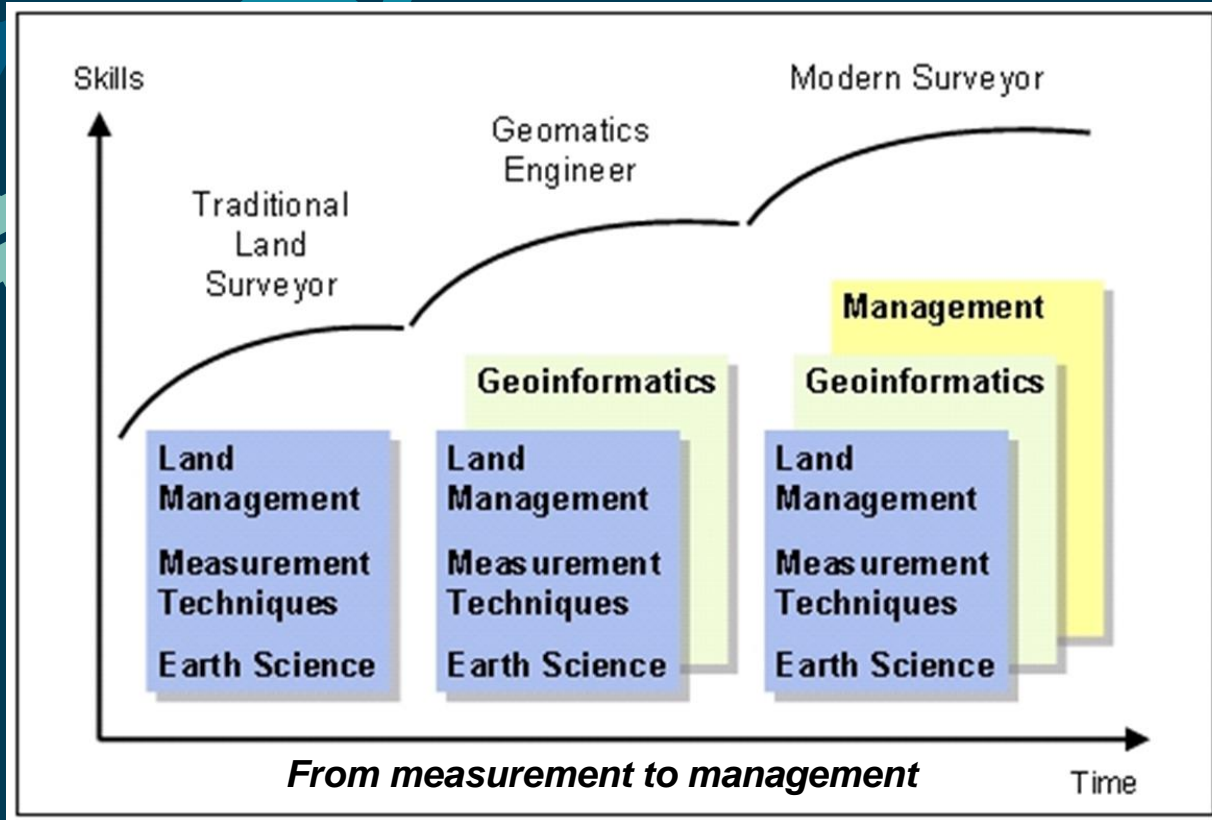

- Context and background of the talk
- Historical highlights: from past to present
- Future vision and directions
- Where are we now? Where are we headed
- Academic curriculum of GE
 - Anticipating the trends
- Take Home Message

From Past to Present

Highlights of an engineering field that spans over a millennium of development

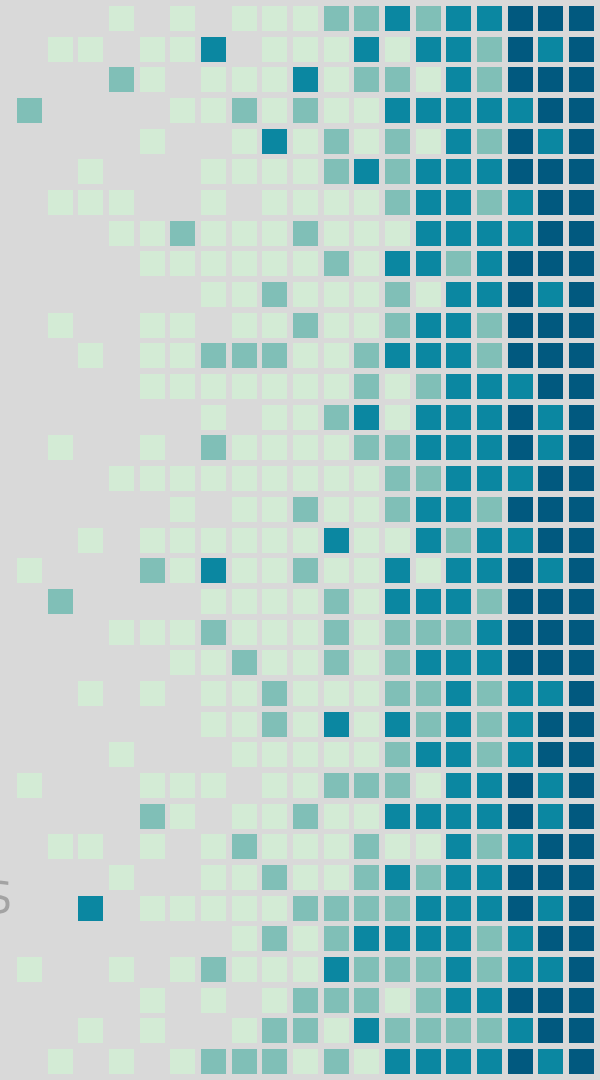

The History of Surveying

Early Days of Surveying

- 1400 B.C.
 - The Egyptians used it to accurately divide land into plots for the purpose of taxation.
- 120 B.C.
 - Greeks developed the science of geometry and were using it for precise land division.
 - Greeks developed the first piece of surveying equipment (Dioptra).
 - Greeks standardized procedures for conducting surveys.

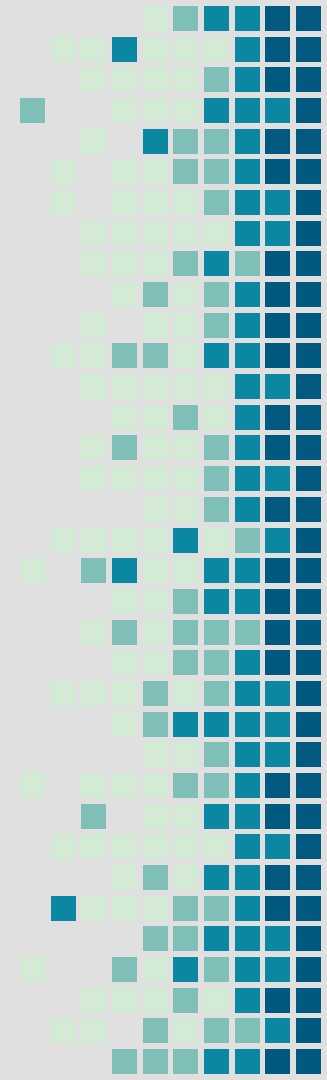

The History of Surveying

Early Days of Surveying

- 1800 A.D. Beginning of the industrial revolution.
 - The importance of "exact boundaries" and the demand for public improvements (i.e. railroads, canals, roads) brought surveying into a prominent position.
 - More accurate instruments were developed.
 - Science of Geodetic and Plane surveying were developed.

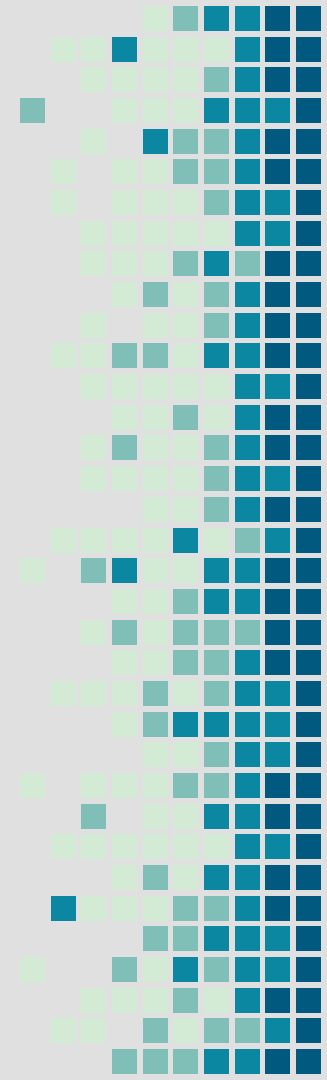

The History of Surveying

Present Surveying – Modern Equipments

- Global Positioning Systems, Geodesy and Remote Sensing- have replaced the older surveying techniques.
- Today, surveying has many purposes:
 - Establishing boundaries between plots of land,
 - mapping the globe, both above and below sea level,
 - devising land, air- and water navigation routes.
 - gathering engineering data for constructing roads, bridges, and buildings.
 - acquiring databases for natural resources management.

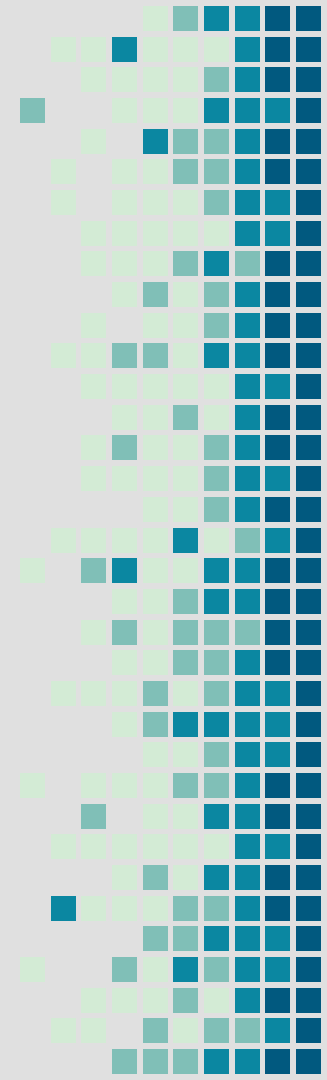

The History of Spatial Information

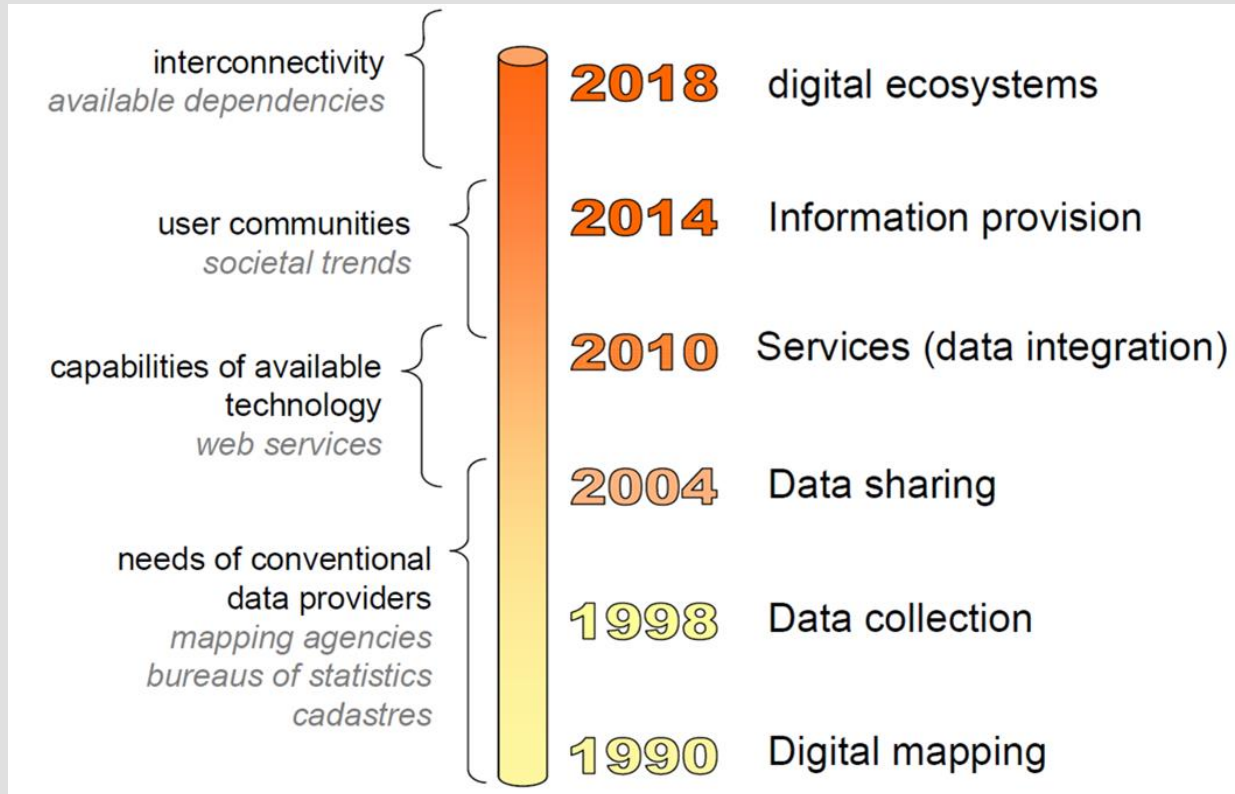

Surveying and Spatial Information

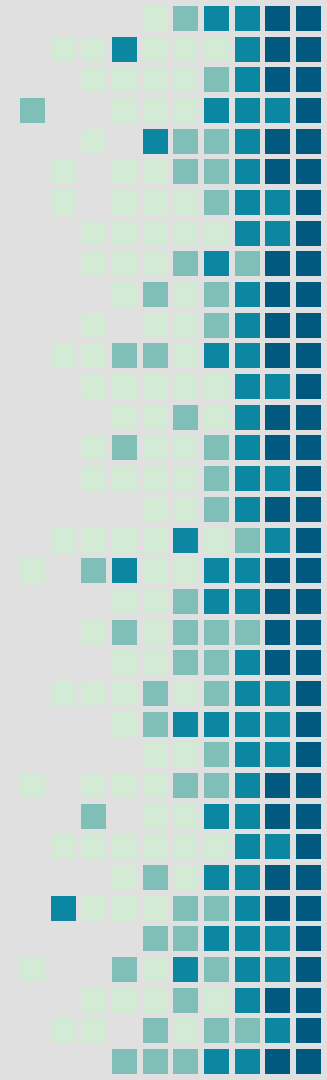
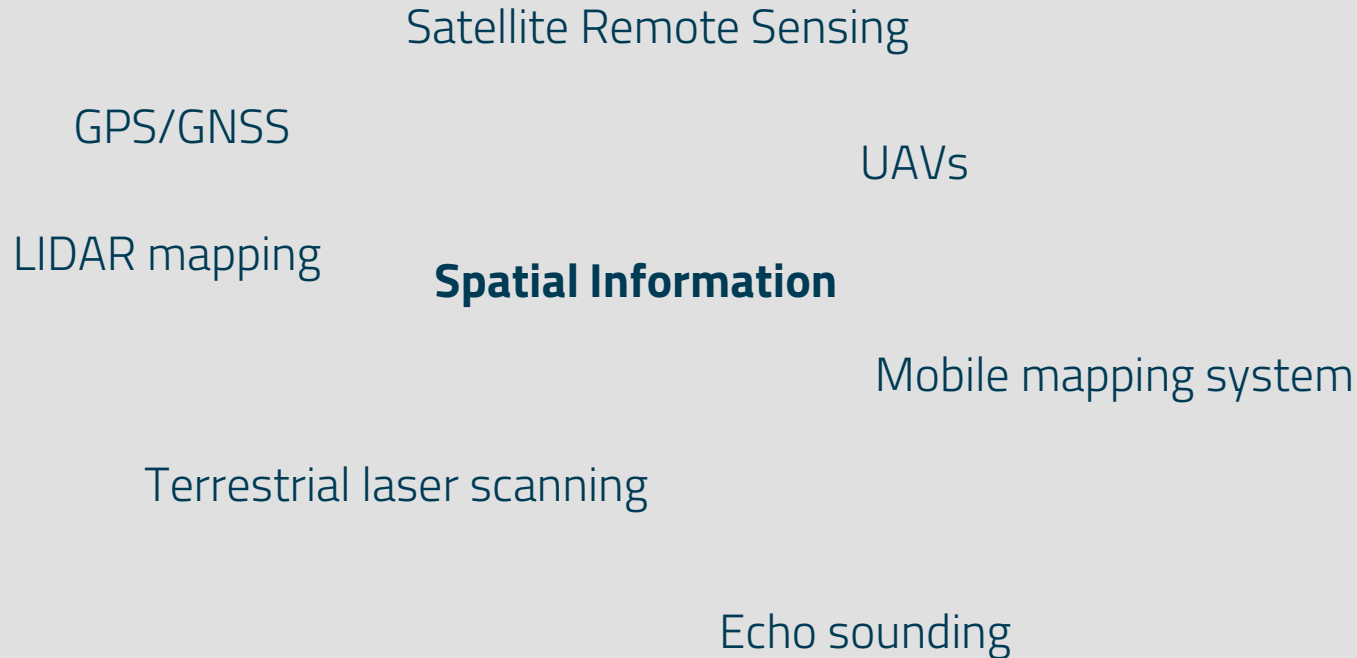



Geodetic Engineers of Today... of Tomorrow...

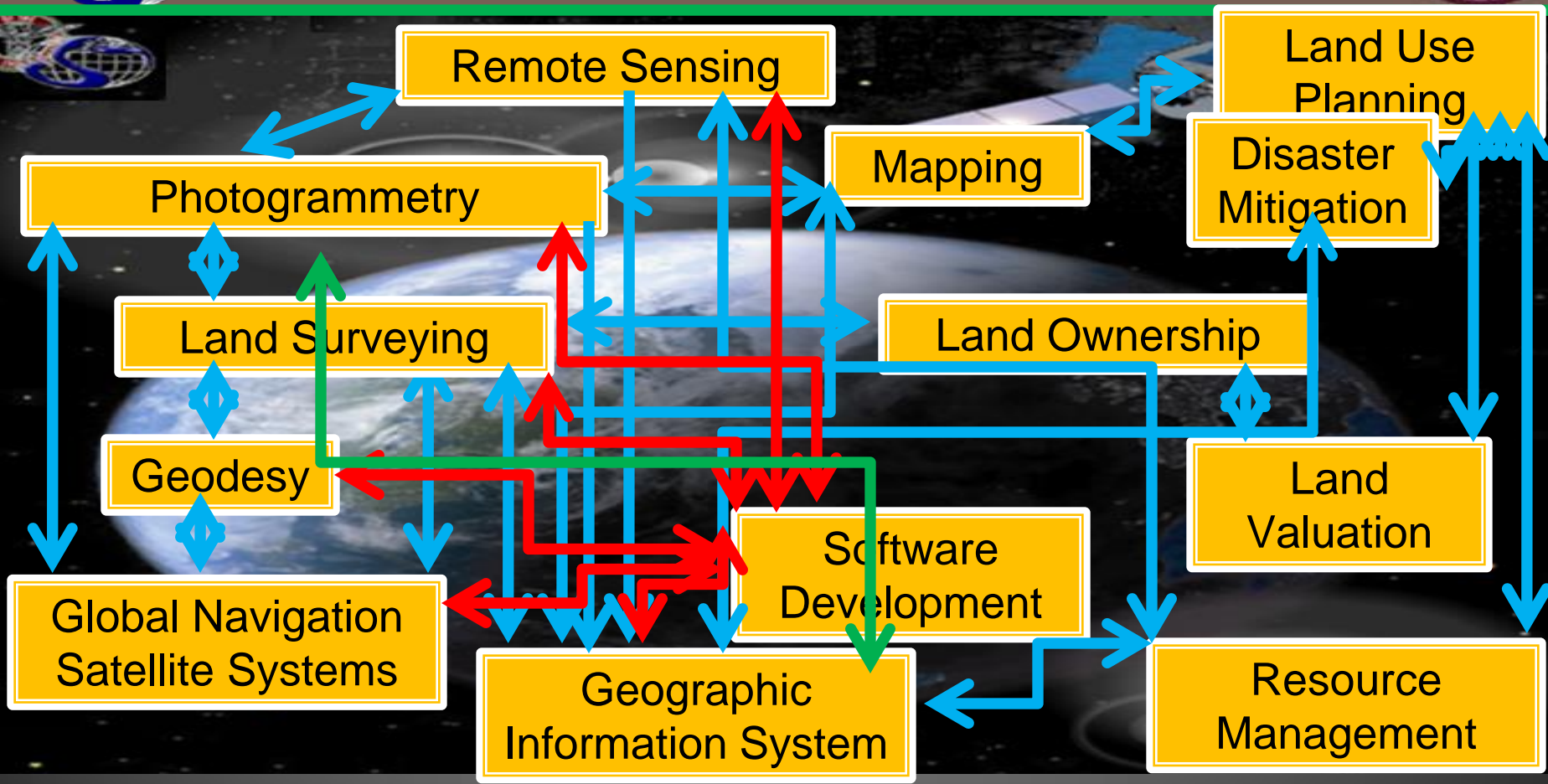

- Context and background of the talk
- Historical highlights: from past to present
- Future vision and directions
- Where are we now? Where are we headed
- Academic curriculum of GE
 - Anticipating the trends
- Take Home Message

Future Vision of Geospatial Information (based from UN-GGIM)

Direction of data creation, maintenance
and management

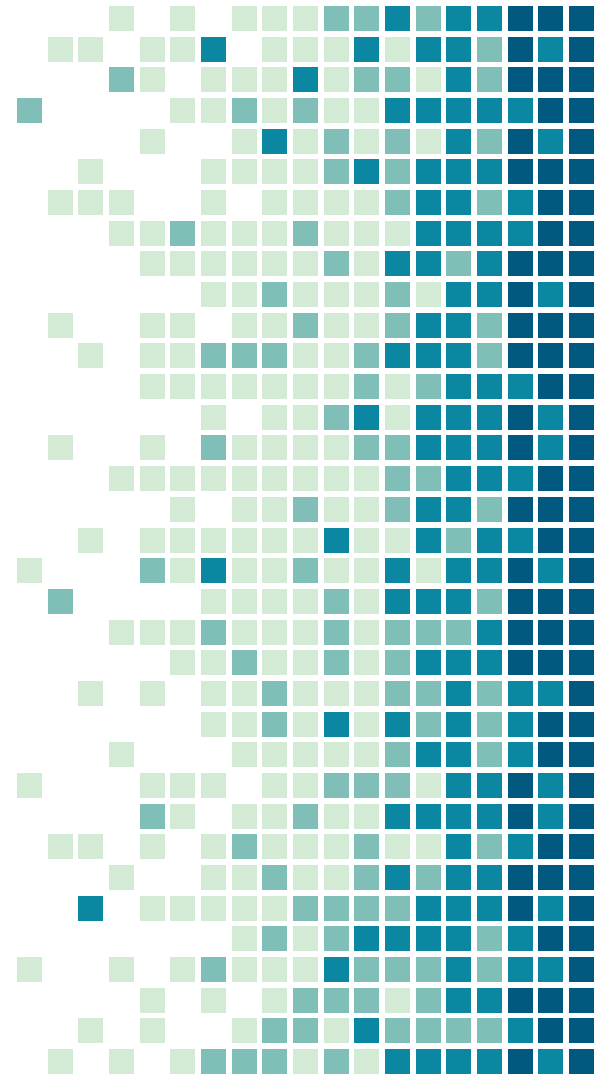

2015 -2025 Future Vision of Geospatial Information (based from UN-GGIM)

- 'Everything happens somewhere' – the new wave of data creation
 - Exponential growth in both the number of data capture methods and in the amount of data being generated and captured.



2015 -2025 Future Vision of Geospatial Information (based from UN-GGIM)

- 'Everything happens somewhere' – the new wave of data creation
 - Objects such as mobile phones, computers, energy meters or any other everyday device will be geospatial beacons.



2015 -2025 Future Vision of Geospatial Information (based from UN-GGIM)

- 'Everything happens somewhere' – the new wave of data creation
 - Active users of social media such as Twitter® and Facebook® will generate more spatially-related information.

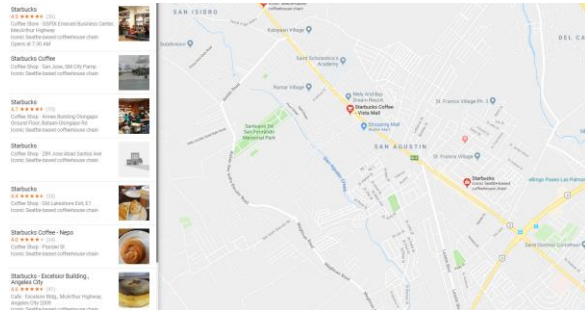

2015 -2025 Future Vision of Geospatial Information (based from UN-GGIM)

- 'Everything happens somewhere' – the new wave of data creation
 - People will be more demanding to a lifestyle that is enhanced by an ever-growing number of geospatial beacons and sensors

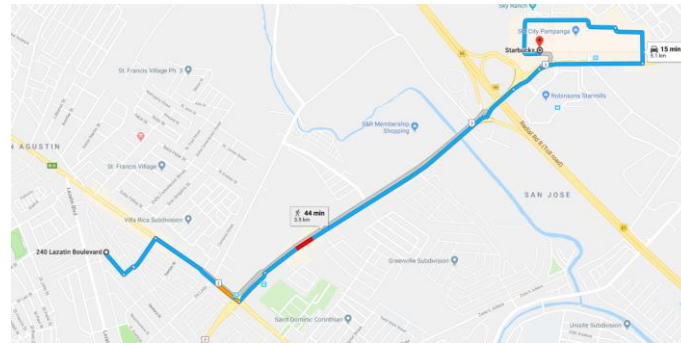
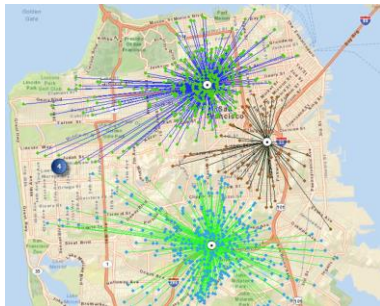

2015 -2025 Future Vision of Geospatial Information (based from UN-GGIM)

- 'Everything happens somewhere' – the new wave of data creation
 - Due to data generation becoming more personal in sourcing, privacy concerns will be a major issue.

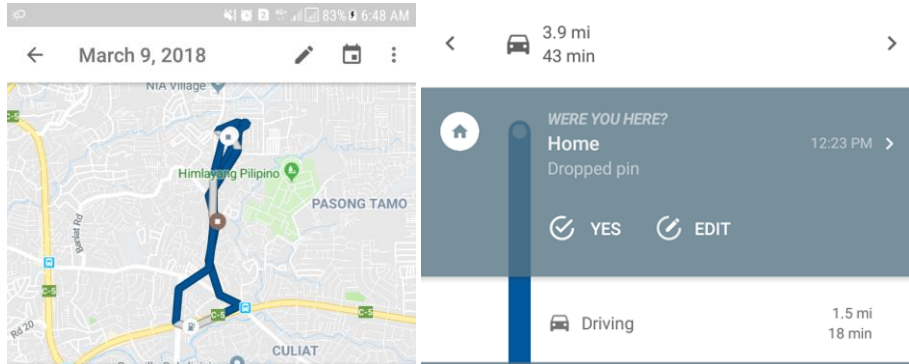

2015 -2025 Future Vision of Geospatial Information (based from UN-GGIM)

- 'Everything happens somewhere' – the new wave of data creation
 - With all these data overlays, we need to have a strong geodetic framework and an up-to-date spatial data infrastructure.

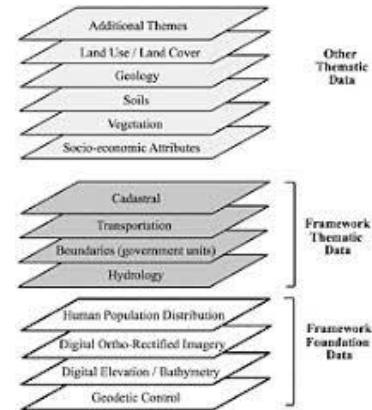
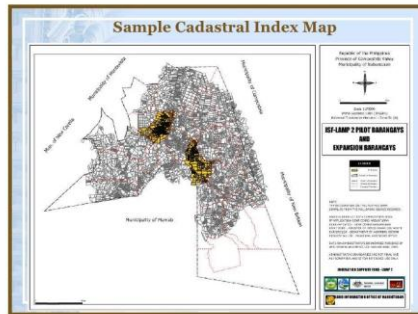
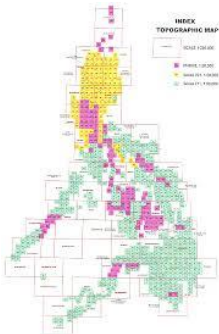

2015 -2025 Future Vision of Geospatial Information (based from UN-GGIM)

- Managing a world of data
 - Huge amount of data (Big Data) requires an ability to make sense of this data.

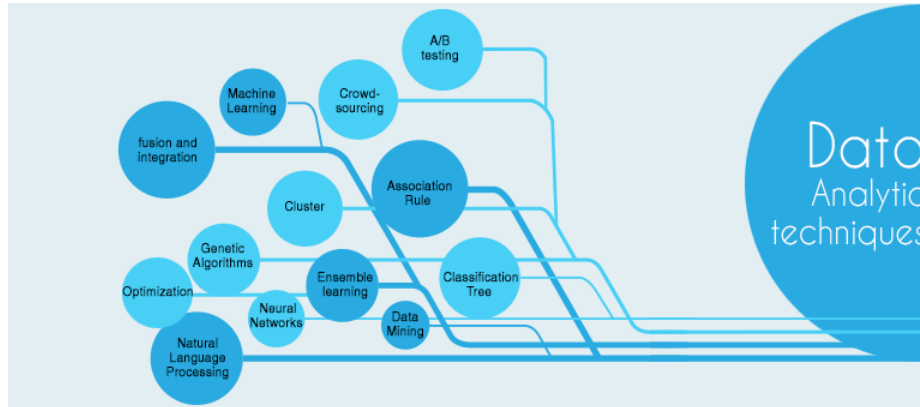

2015 -2025 Future Vision of Geospatial Information (based from UN-GGIM)

- Managing a world of data
 - Currently suffering from information overload, we have an ever-growing requirement to be able to find the right information at the right time to be given to the right people.

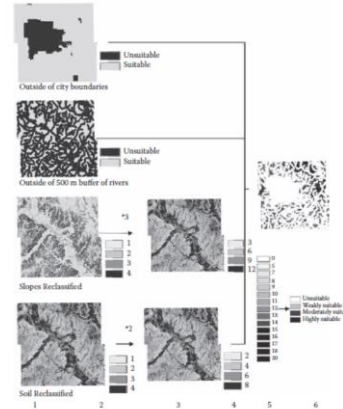
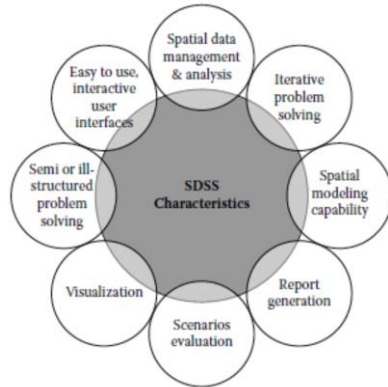

2015 -2025 Future Vision of Geospatial Information (based from UN-GGIM)

- Managing a world of data
 - There is an increasing demand for real-time information and real-time modelling

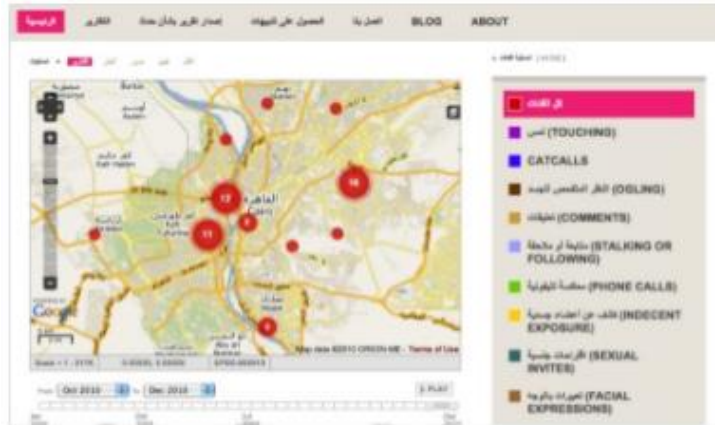

Source: psfk.com

2015 -2025 Future Vision of Geospatial Information (based from UN-GGIM)

- Managing a world of data
 - Distributed systems for processing unstructured and semi-structured data will emerge.

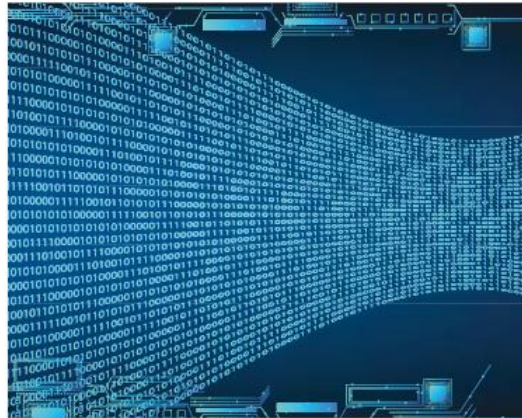

Source: cgartist/Shutterstock.com

2015 -2025 Future Vision of Geospatial Information (based from UN-GGIM)

- Managing a world of data
 - As this will continue increase, there is a need to get more people involve in analytics and data management.
 - Geodetic Engineers need to expand their ability portfolio from gathering spatial data to managing and analysing spatial data.

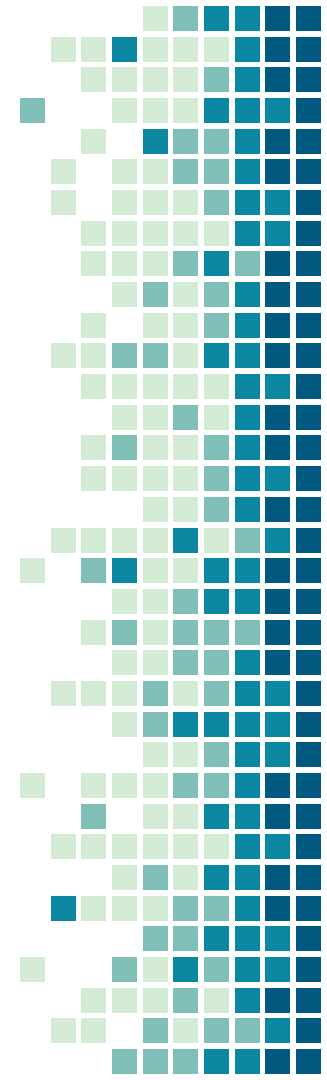
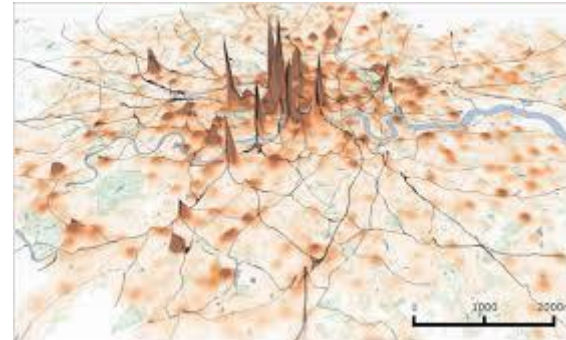
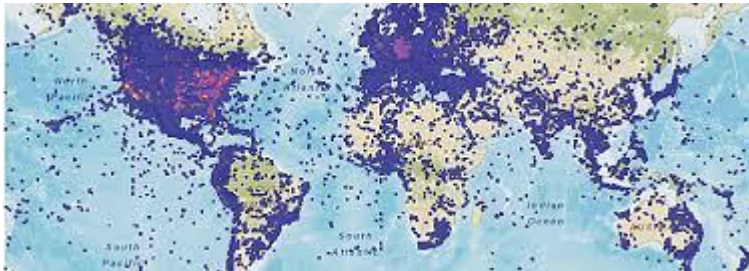

2015 -2025 Future Vision of Geospatial Information (based from UN-GGIM)

- Linked data and the 'Internet of Things'
 - Through the use of Web, the ability to link information will be increasingly important.
 - Linked data offers the opportunity to connect data to other pieces of data on the Web, *contextualising* and adding value to the information that already exists.

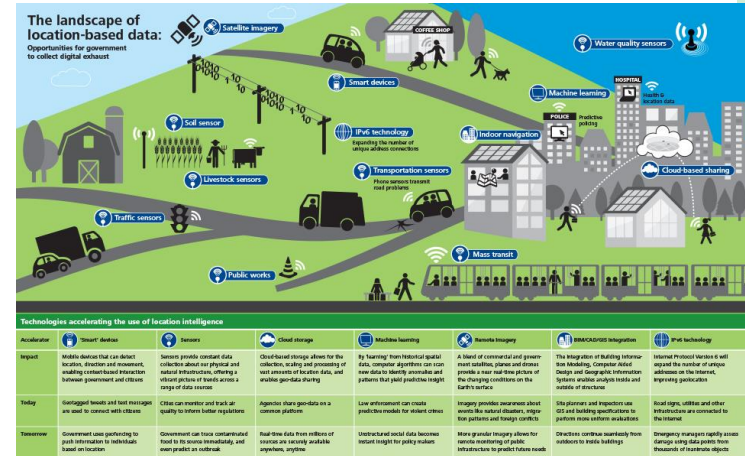

Source: Deloitte University Press

2015 -2025 Future Vision of Geospatial Information (based from UN-GGIM)

- Linked data and the 'Internet of Things'
 - Semantic technologies will play an important role when it comes to publishing and making sense of data

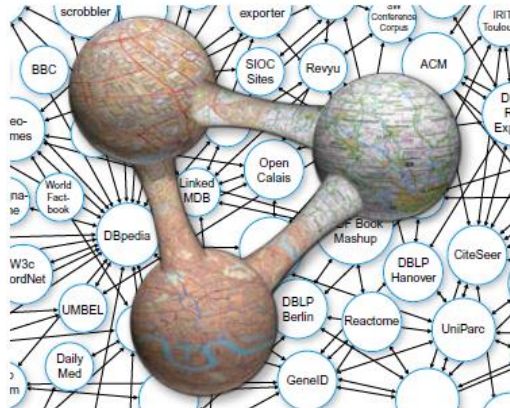

Syntactic
VS
Semantics

Source: Ordnance
Survey/linkeddata.org

2015 -2025 Future Vision of Geospatial Information (based from UN-GGIM)

- Linked data and the 'Internet of Things'
 - With an estimate of over 50 billion things, most with location artefacts, connected by 2020, location-based services will definitely influence people's decision making.



Source: Kachwanya.com

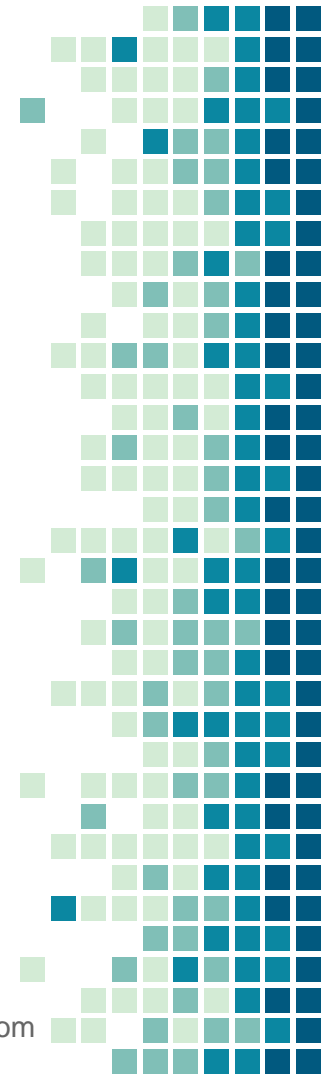

2015 -2025 Future Vision of Geospatial Information (based from UN-GGIM)

- Linked data and the 'Internet of Things'
 - Geospatial information is needed, more than ever, to assist the evolution of this connected ecosystem.
 - Geodetic Engineers, being in the frontline of generating quality spatial information, should impose their involvement in meeting this requirement.

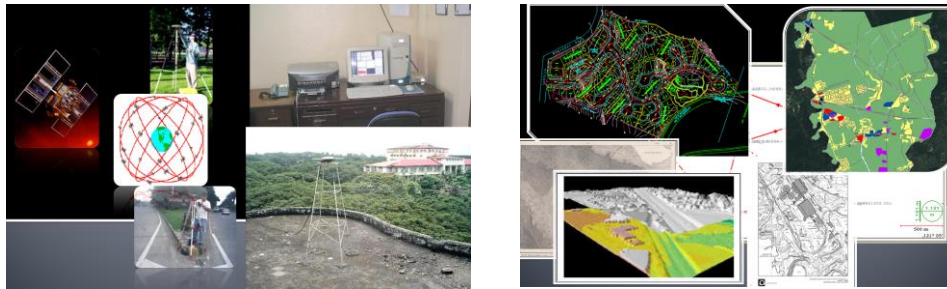

2015 -2025 Future Vision of Geospatial Information (based from UN-GGIM)

- Cloud computing
 - Infrastructure and software hosted elsewhere in a shared manner, provides a means to host and serve significant volumes of data

GeoServer

username

Layer Preview

List of all layers configured in GeoServer and provides previews in various formats for each.

<< < 1 > >> Results 1 to 24 (out of 24 items)

Type	Title	Name	Common Formats
■	World rectangle	tiger:giant_polygon	OpenLayers KML GML
●	Manhattan (NY) points of interest	tiger:poi	OpenLayers KML GML
■	Manhattan (NY) landmarks	tiger:poly_landmarks	OpenLayers KML GML

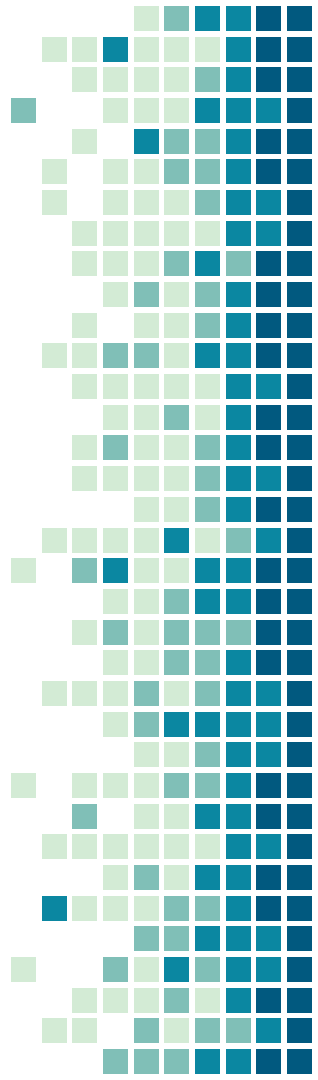

2015 -2025 Future Vision of Geospatial Information (based from UN-GGIM)

- Cloud computing
 - Infrastructure as a service (IaaS), platform as a service (PaaS), software as a service (SaaS) and data as a service (DaaS) offers the required infrastructure to meet the geospatial demand



2015 -2025 Future Vision of Geospatial Information (based from UN-GGIM)

- Cloud computing
 - Although cloud computing is a major field of computer science, GE if not knowledgeable of the Hows, should be knowledgeable of the Whys.



2015 -2025 Future Vision of Geospatial Information (based from UN-GGIM)

- Open-source
 - likely to grow significantly as a viable alternative to proprietary suppliers



2015 -2025 Future Vision of Geospatial Information (based from UN-GGIM)

- Open standards
 - number of organisations, at both national and international levels, responsible for the development of standards for use in acquiring, implementing, maintaining and using geospatial data.



2015 -2025 Future Vision of Geospatial Information (based from UN-GGIM)

- Open standards
 - **Open Geospatial Consortium (OGC®)** and the **International Organization for Standardization (ISO®)**

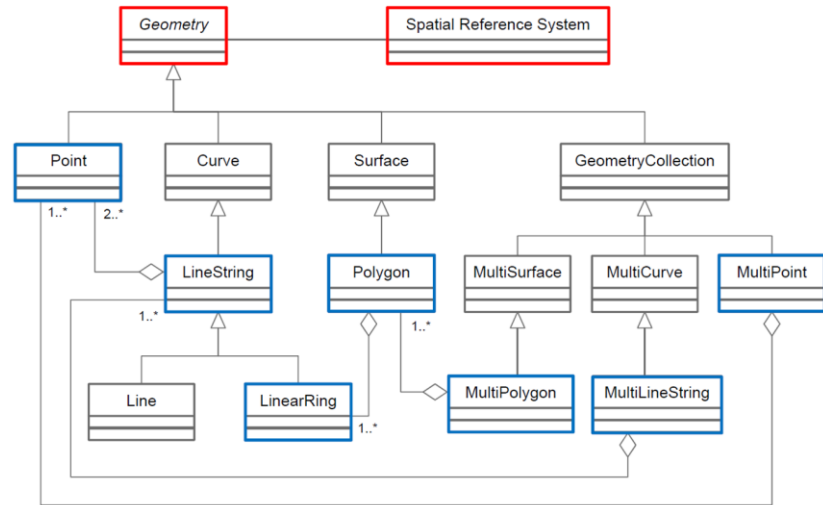

2015 -2025 Future Vision of Geospatial Information (based from UN-GGIM)

- Trends in 'professional' data creation and maintenance
 - moving from two dimensional (2D) mapping through to three dimensional (3D) and on to four dimensional (4D) visualisations



2015 -2025 Future Vision of Geospatial Information (based from UN-GGIM)

- Trends in 'professional' data creation and maintenance
 - integration of 'external' 3D information with business information management systems that will use 'internal' and below-ground 3D to create integrated walk-through models



2015 -2025 Future Vision of Geospatial Information (based from UN-GGIM)

- Trends in 'professional' data creation and maintenance
 - quality of aerial imagery will continue to increase in the next five to ten years



2015 -2025 Future Vision of Geospatial Information (based from UN-GGIM)

- Trends in 'professional' data creation and maintenance
 - proliferation of low-cost launch systems and affordable satellites, with increasingly-powerful multi-band sensors,

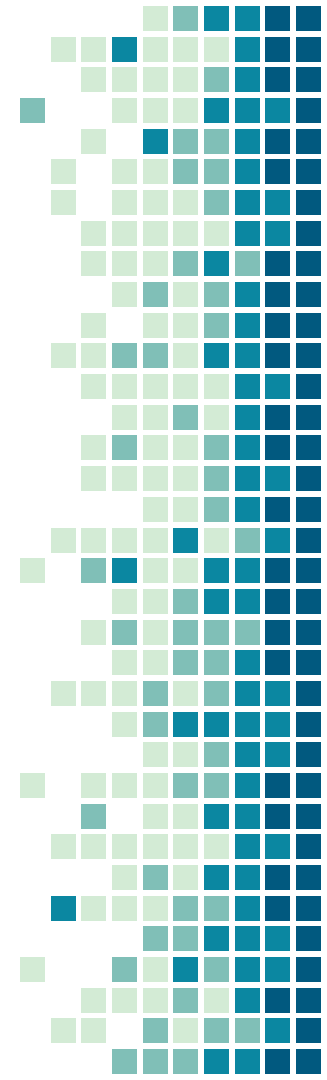

2015 -2025 Future Vision of Geospatial Information (based from UN-GGIM)

- Trends in 'professional' data creation and maintenance
 - Unmanned aerial vehicles (UAVs) in the civilian sector are likely to be used increasingly as an additional method of data capture and will complement satellite remote sensing and aerial imagery.,



2015 -2025 Future Vision of Geospatial Information (based from UN-GGIM)

- Trends in 'professional' data creation and maintenance
 - Mobile mapping systems will be upgraded for capturing and processing both street-level visual information, points of interest (POI) and attribute data in more detail.

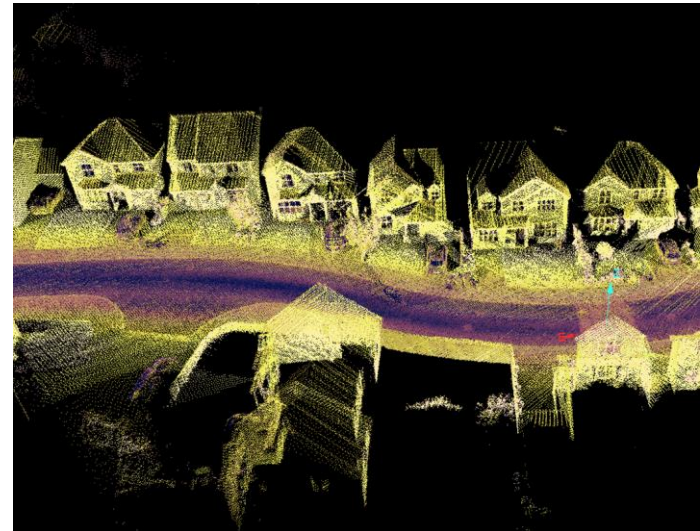

2015 -2025 Future Vision of Geospatial Information (based from UN-GGIM)

- Positioning ourselves in the next five to ten years
 - GNSS technology is now mainstream
 - In 2015, there will be over 100 GNSS satellites in orbit



2015 -2025 Future Vision of Geospatial Information (based from UN-GGIM)

- Positioning ourselves in the next five to ten years
 - Improvements in satellite gravimetry missions are starting to challenge the way that vertical reference systems are defined



2015 -2025 Future Vision of Geospatial Information (based from UN-GGIM)

- Positioning ourselves in the next five to ten years
 - Reference frames are becoming more accurately defined with each iteration as technology and techniques improve
 - Satellite laser ranging (SLR),
 - very long baseline interferometry (VLBI) and
 - Doppler Orbitography and Radiopositioning Integrated by Satellite (DORIS) datasets.



2015 -2025 Future Vision of Geospatial Information (based from UN-GGIM)

- Positioning ourselves in the next five to ten years
 - National reference frames are increasingly becoming more aligned to globally-standardised geodetic reference frameworks
 - – an example being the International Terrestrial Reference Frame (ITRF) – as well as GNSS reference frames



2015 -2025 Future Vision of Geospatial Information (based from UN-GGIM)

- Positioning ourselves in the next five to ten years
 - Indoor positioning
 - ultra-wideband, accelerometers
 - and radio frequency identification (RFID),



- Context and background of the talk
- Historical highlights: from past to present
- Future vision and directions
- Where are we now? Where are we headed
- Academic curriculum of GE
 - Anticipating the trends
- Take Home Message

Where are we now? Where are we headed?

Philippine status in spatial information systems

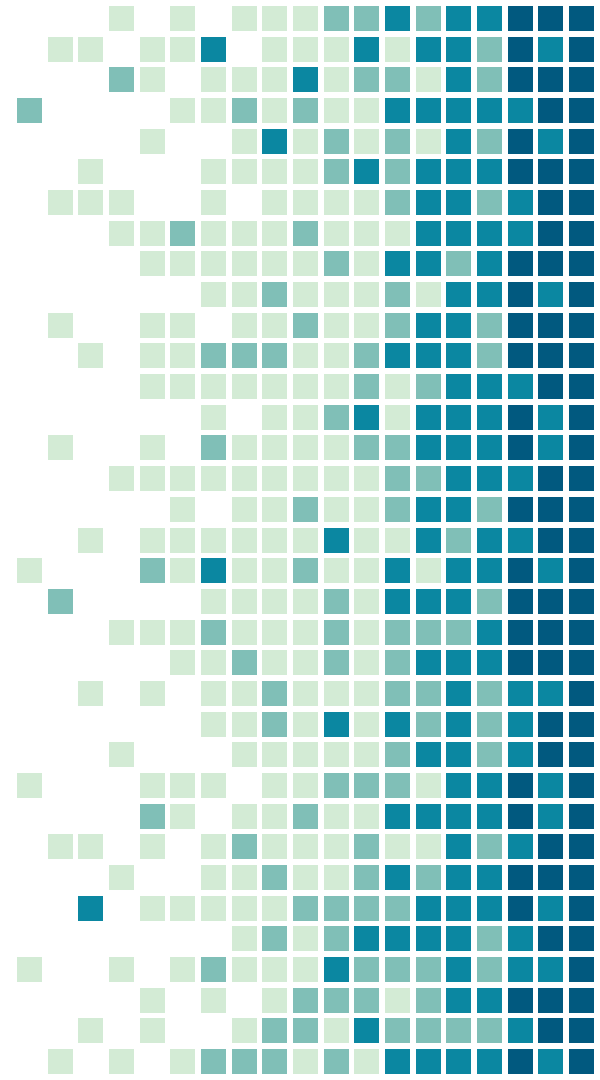

Internet Statistics in the Philippines

1. 43.5% of Filipinos accessed the Internet, five percentage points higher than the Southeast Asian regional average of 38%.
2. Internet penetration amongst consumers aged 15 to 19 was close to two-thirds (65%) and nearly half of those in their 20"s were online (48%).
3. 52% of Filipinos had a computer with high speed Internet connection at home.
4. Home was the most common Internet access point for those aged 30 years and above close to nine in ten Internet users aged 50 years and above (86%) cite "home" as their main point of access.
5. Close to one quarter of Filipinos Internet users (24%) accessed the Internet on a daily basis via a mobile phone and 56% intend to access the Internet via a mobile phone in the next 12 months.
6. Over two thirds of Filipino digital consumers (67%) had visited social networking sites, compared to 40% who used email.
7. The Philippines ranked second highest for the number of people who had ever "liked" or followed a brand, company or celebrity on a social networking site (75%).
8. Close to two thirds of digital Filipinos (64%) used social media as a resource in purchase decision making.

LAMS Philippines

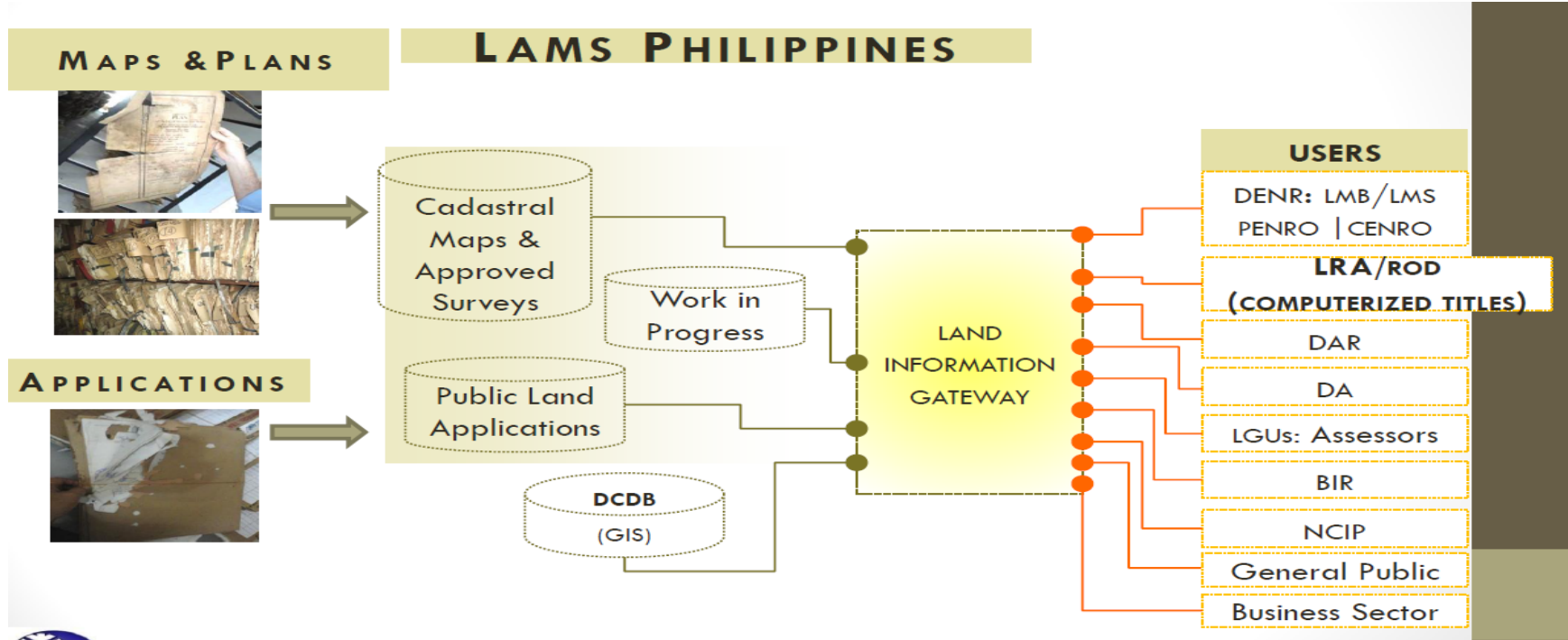

LAMS Philippines Installation

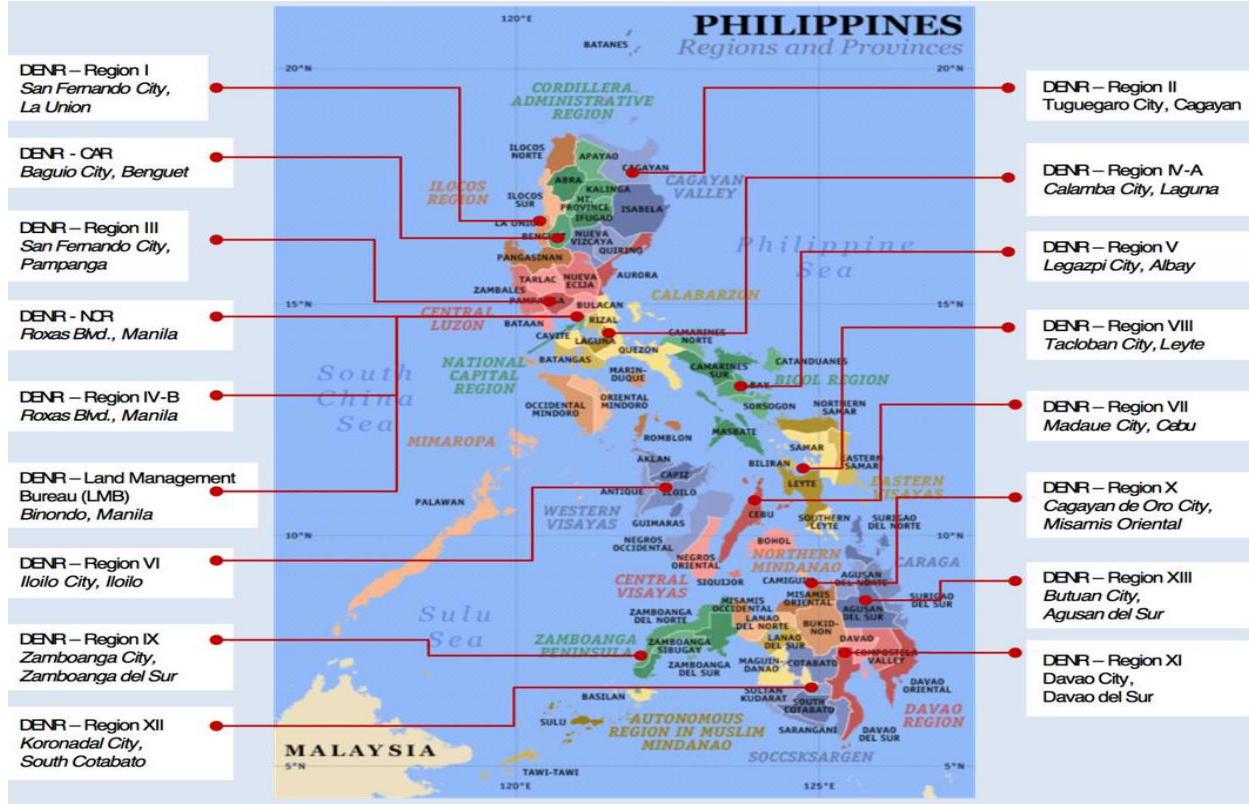

Nationwide Database of Land Records

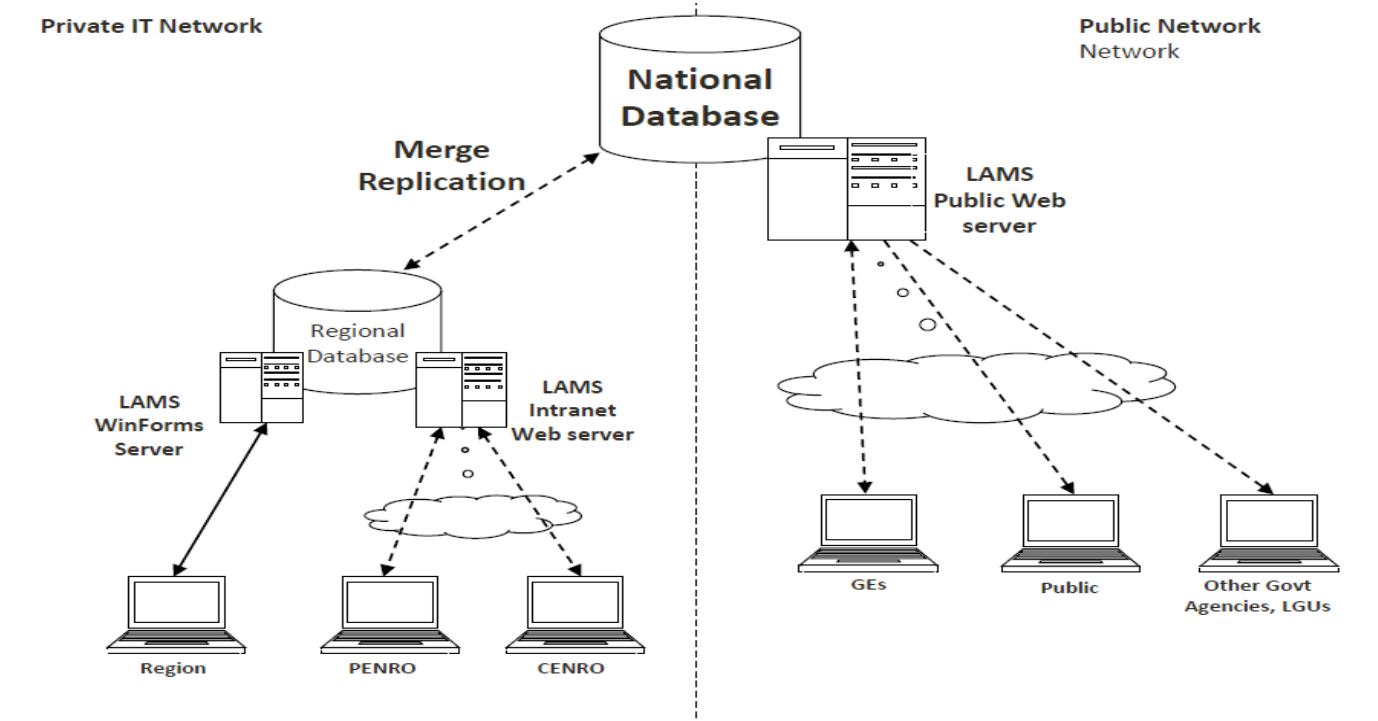

Digital Land Survey Data (DLSD)

- A uniform format in the submission of survey data as input to LAMS.
- Improvement in the processing time particularly in the submission and approval of survey returns.
- Establishment of a standard format for use in data exchange with other government agencies and other stakeholders
- Pre-requisite as interim phase towards paperless submission of survey returns for computerized verification and approval of surveys.

DLSD File

The Digital Land Survey Data is a file for online lodgement of survey plans. This shall allow for faster verification and approval of plans

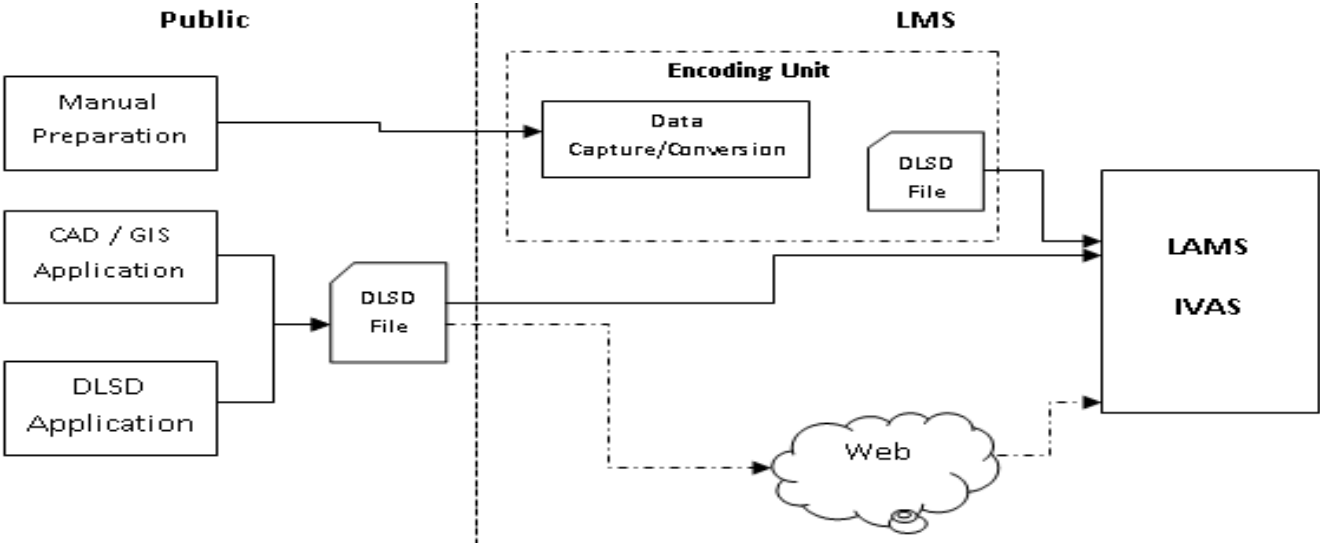

Future Submission of Survey Plans

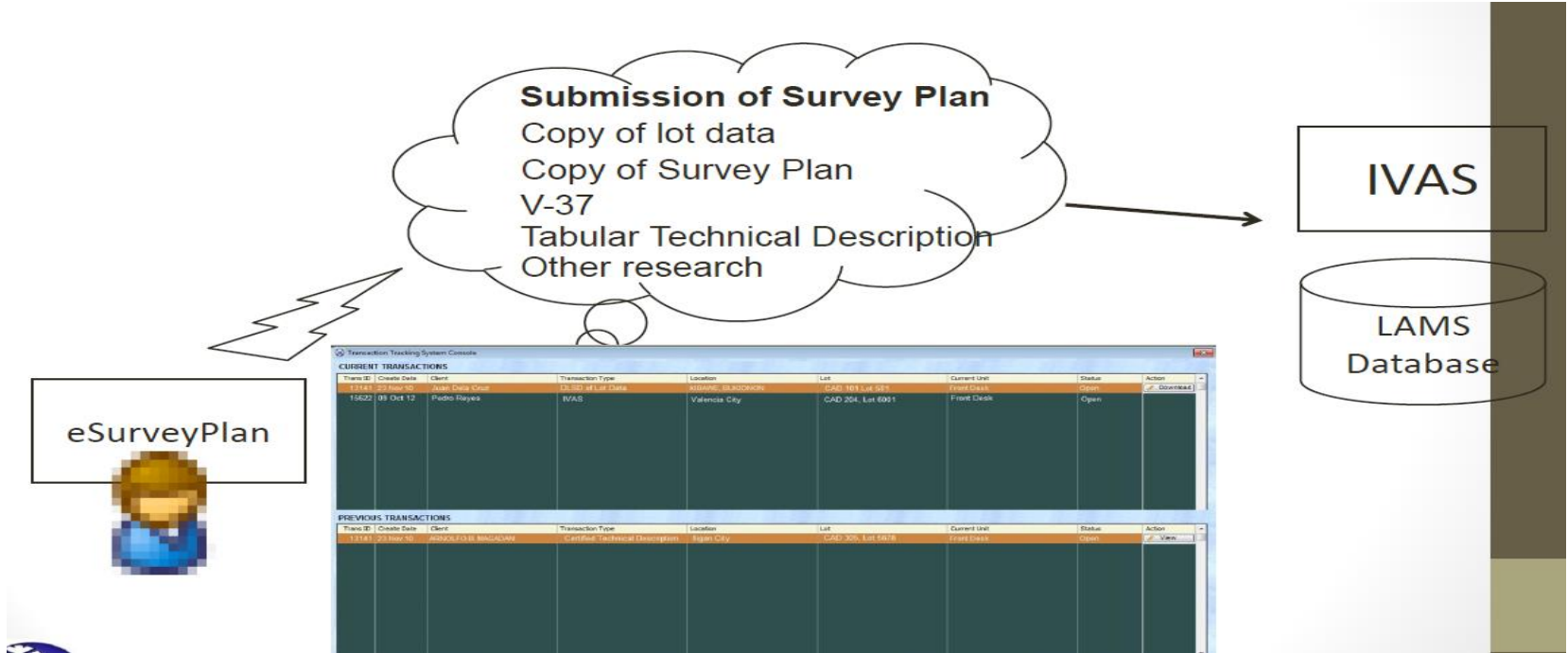

LAMS e-Survey Plan

LAMS eSurveyPlan v1.10 [beta release], Licensed to SAN BUENAVENTURA, AVELINO L. - [C:\Users\User\Desktop\Region4a\MERIDIANPLACE-FILINVEST-block.xml]

File Transaction Tools Help

Resultant Lot

- B1 L1
- B1 L2
- B1 L3
- B1 L4
- B1 L5
- B1 L6
- B1 L7
- B1 L8
- B1 L9
- B1 L10
- B1 L11
- B1 L12
- B1 L13
- B1 L14
- B1 L15
- B1 L16
- B1 L17
- B1 L18
- B1 L19
- B1 L20
- B1 L21
- B1 L22
- B1 L23
- B1 L24
- B1 L25
- B1 L26
- B1 L27
- B1 L28
- B2 L1
- B2 L2
- B2 L3
- B2 L4

complex surveys created from GeSurvey or other CAD programs may be viewed and edited using the eSurveyPlan

From To Shot Cor Deg Min Sec Distance

Northing Easting

Resultant Lot Mother Lot Boundary Block Traverse Draft Road Label

The screenshot displays a software window titled "LAMS eSurveyPlan v1.10 [beta release], Licensed to SAN BUENAVENTURA, AVELINO L. - [C:\Users\User\Desktop\Region4a\MERIDIANPLACE-FILINVEST-block.xml]". The interface includes a menu bar (File, Transaction, Tools, Help), a toolbar with various icons, and a main drawing area. On the left, a "Resultant Lot" list contains items from B1 L1 to B2 L4. A red-bordered text box highlights the text: "complex surveys created from GeSurvey or other CAD programs may be viewed and edited using the eSurveyPlan". Below this list is a table for recording survey data with columns for "From To", "Shot", "Cor", "Deg", "Min", "Sec", and "Distance", along with "Northing" and "Easting" fields. The main drawing area shows a detailed survey plan with a grid of lots, roads, and boundaries. Labels include "CREAK", "ROAD", "MALABON ESTATE", and "LOT 3296-C, Pd.04-051993". A scale of 1:882 is indicated. At the bottom, a toolbar contains checkboxes for "Resultant Lot", "Mother Lot", "Boundary", "Block", "Traverse", "Draft", "Road", and "Label", all of which are checked. A zoom level of 0 is shown in the bottom right corner.

Geospatial Open Data

The image is a screenshot of a web browser displaying the Philippine Geoportal website. The browser's address bar shows the URL 'www.geoportal.gov.ph'. The page features a dark navigation bar with links for HOME, WHAT IS GEOPORTAL?, MODULES, DOWNLOADS, PARTNER AGENCIES, and CONTACT US. Below the navigation bar is the Philippine Geoportal logo, which includes the text 'Philippine Geoportal' and the tagline 'One Nation One Map'. The main content area has a dark background and is titled 'WHAT IS GEOPORTAL?'. It contains a paragraph explaining the portal's purpose and three columns of information: 'DISCOVER DATA' (with a magnifying glass icon), 'USE DATA' (with a map icon), and 'SHARE DATA' (with a share icon). A vertical 'Feedback' button is visible on the right side of the page.

www.geoportal.gov.ph

HOME WHAT IS GEOPORTAL? MODULES DOWNLOADS PARTNER AGENCIES CONTACT US

Philippine Geoportal
One Nation One Map

WHAT IS GEOPORTAL?

Geoportal is used to find and access geospatial data and services.

The Philippine Geoportal also advocates the use of standard multiscale basemaps that serve as tools for strategic planning, decision making, situational analysis and other common requirements.

DISCOVER DATA
You can search or browse geospatial data using our online [map viewer](#).

USE DATA
Download geospatial data for offline use or consume web services straight from your application.

SHARE DATA
Got data you want to share? Use the [map builder](#) for uploading geospatial data and defining related metadata.

Feedback

Diwata-1 Philippines' Micro-satellite Project

- Missions of Diwata-1 are
 - Disaster monitoring
 - Data collection for resource management
 - Scientific observation over the Philippines
- List of Payloads is as follows:
 - High Precision Telescope (HPT)
 - Spaceborne Multi-spectral Imager (SMI with LCTF)



Airborne LIDAR Mapping

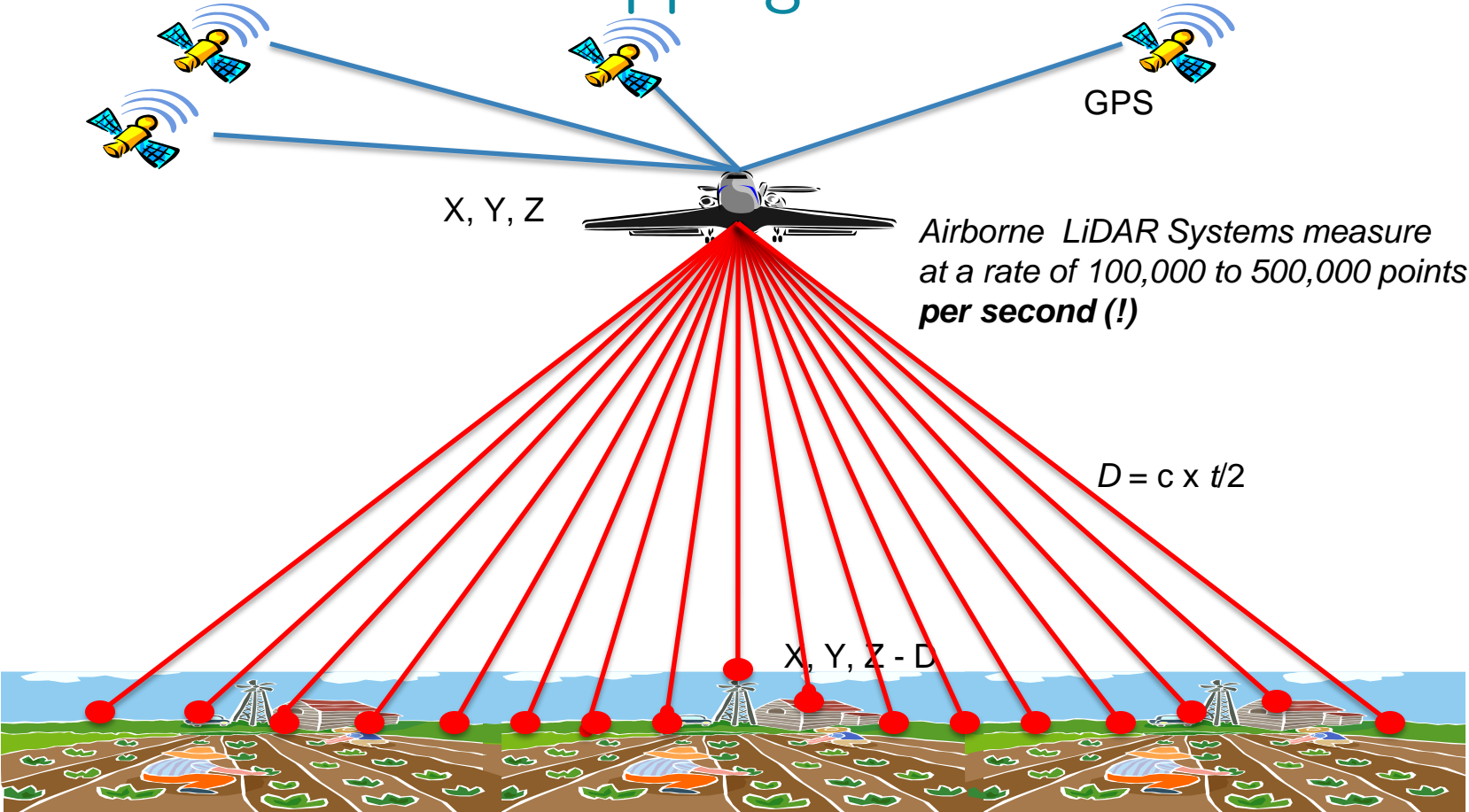

Hyperspectral
Control
Rack

Full wave form
Digitizer

LIDAR
Control Rack

LIDAR Sensor

Hyperspectral
Sensor



Cebu City Skyline from DREAM LIDAR

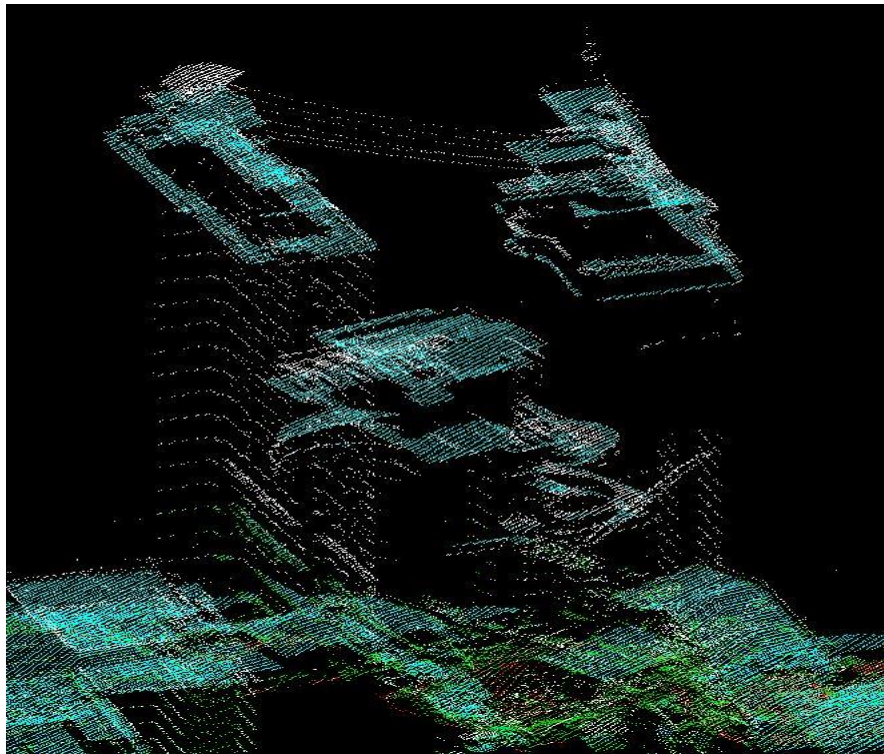

Crown Regency Hotel, Cebu City

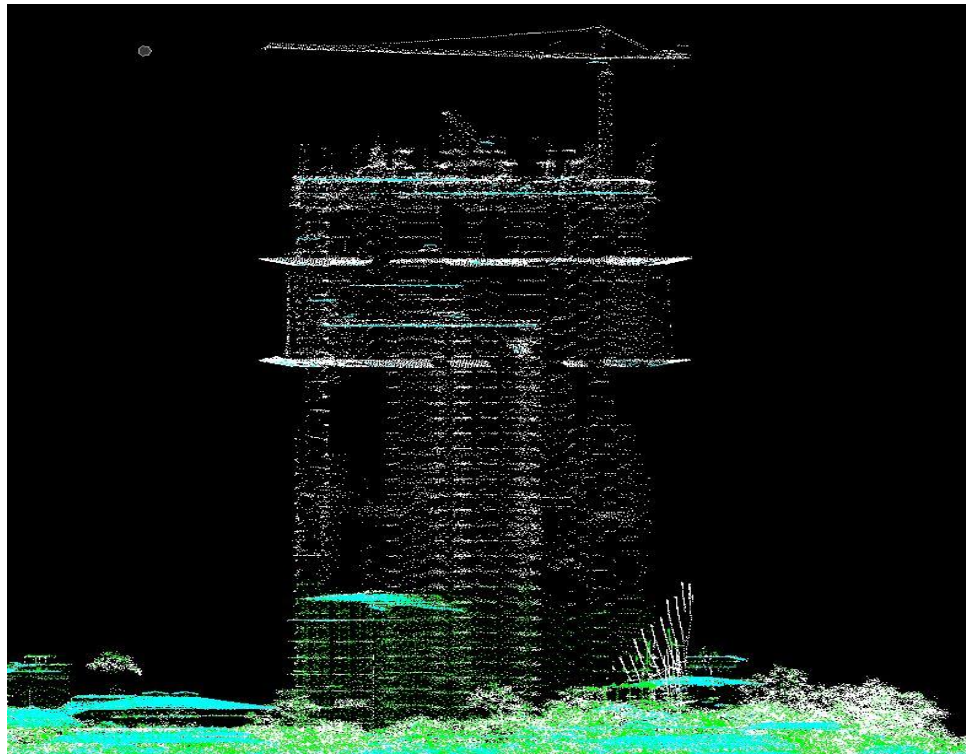

UAV Mapping Systems

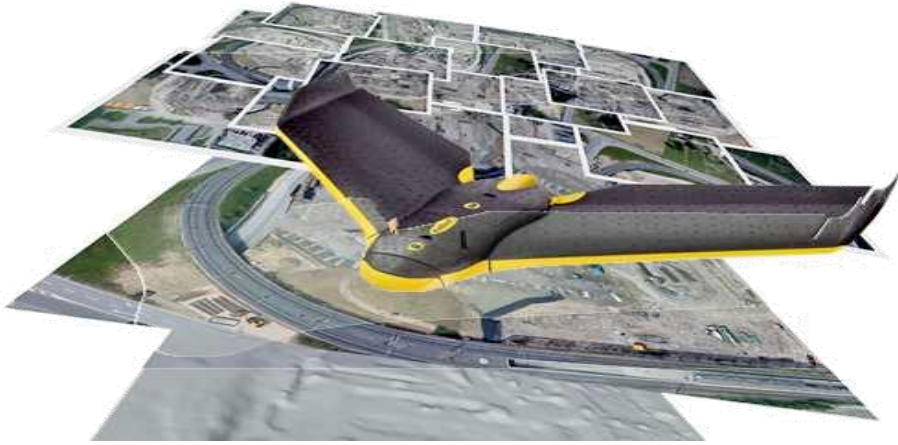

Fixed wing



Rotary wing

11/21/2016



142 m

Image © 2016 DigitalGlobe

Google earth

11/21/2016

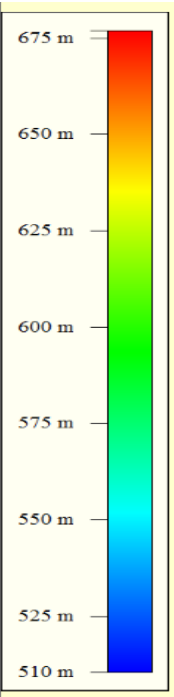
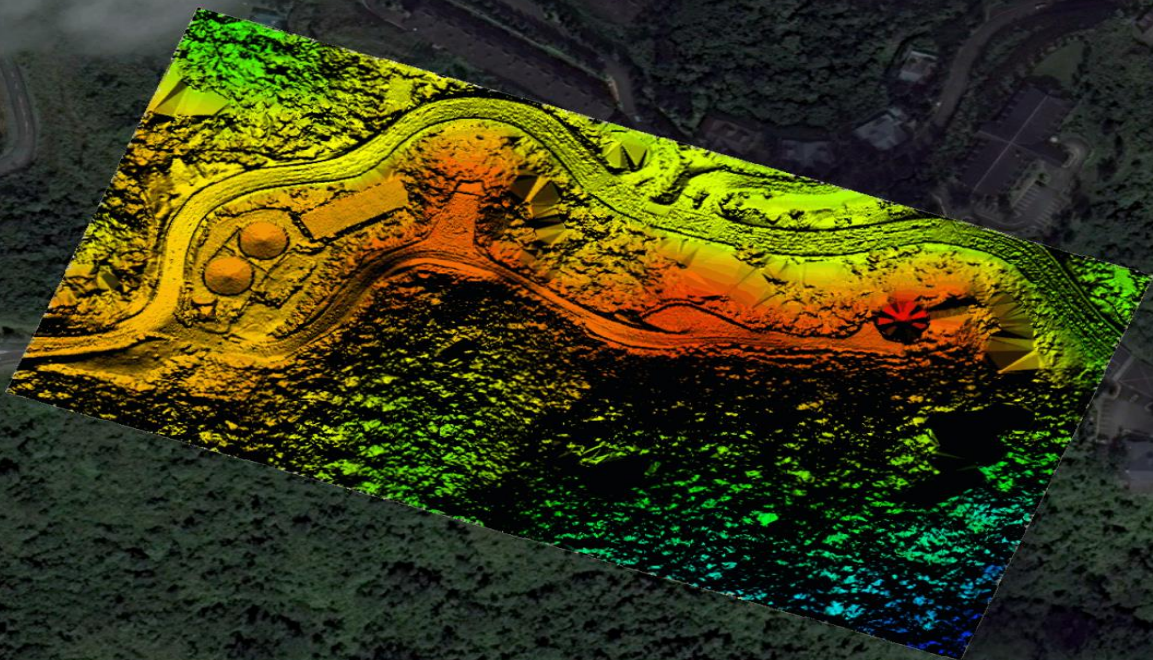

142 m

Image © 2016 DigitalGlobe

Google earth

Manila Metropolitan Theater

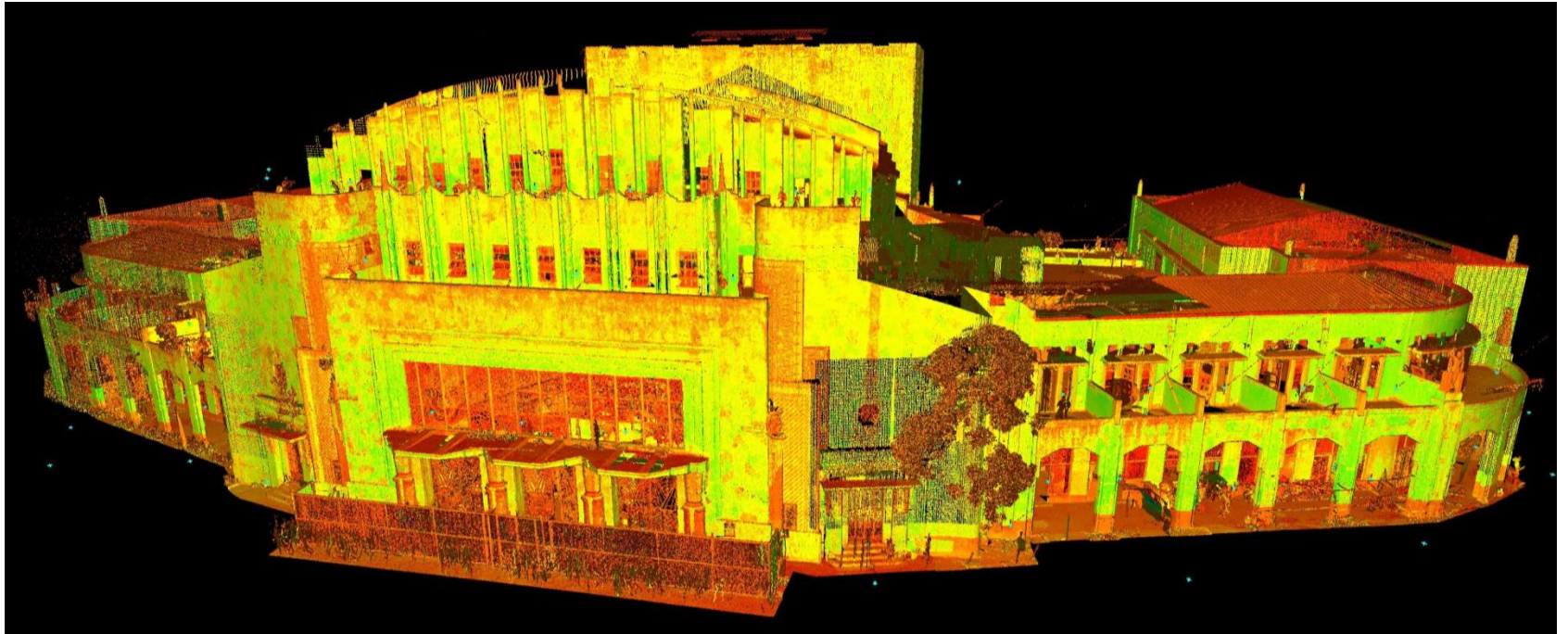

Methodology

- Hardware
 - Leica Scan Station C10
 - Canon DSLR 60D with fisheye lens and nodal ninja



Mobile Mapping Systems (MMS)



Mobile Mapping Systems (MMS)

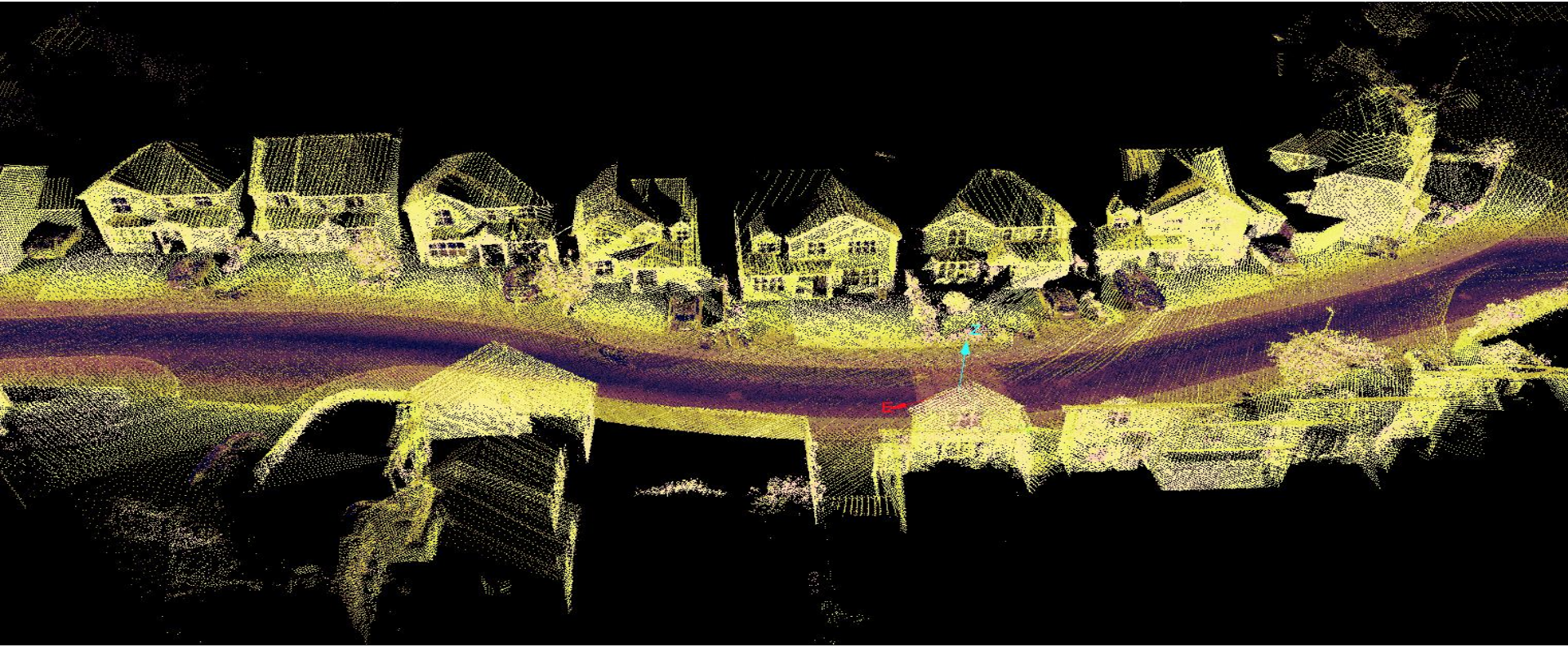

From single-beam to multibeam echosounding

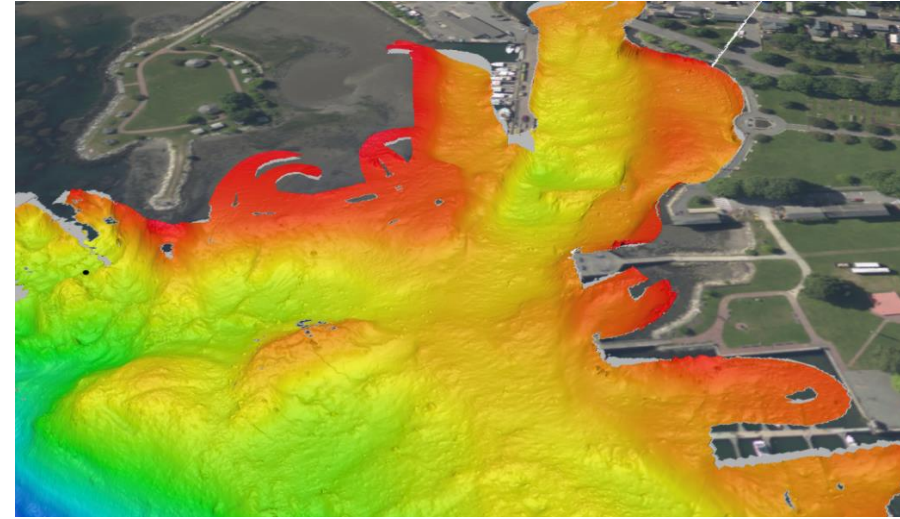
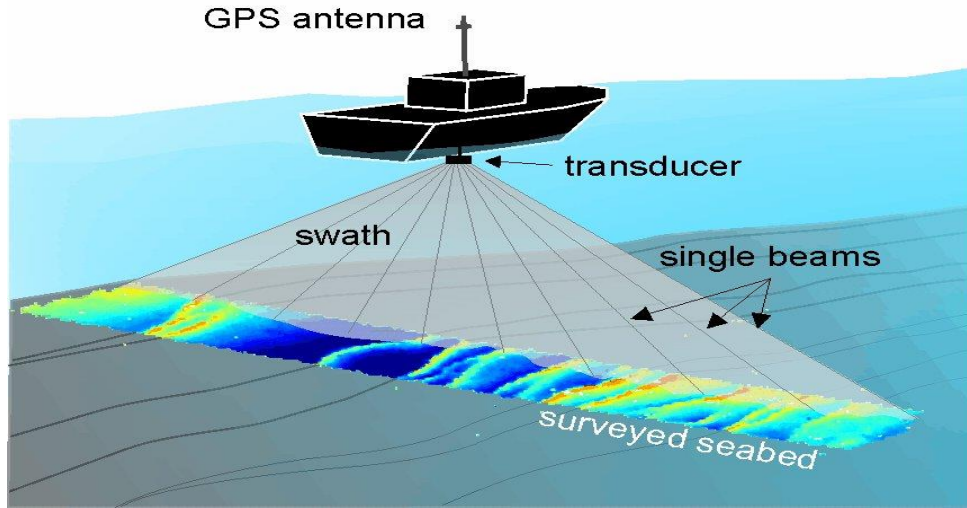

- The worldwide industry is slowly adapting digital technologies to gather coastal and marine information

From on-surface to underwater sensors and measurements

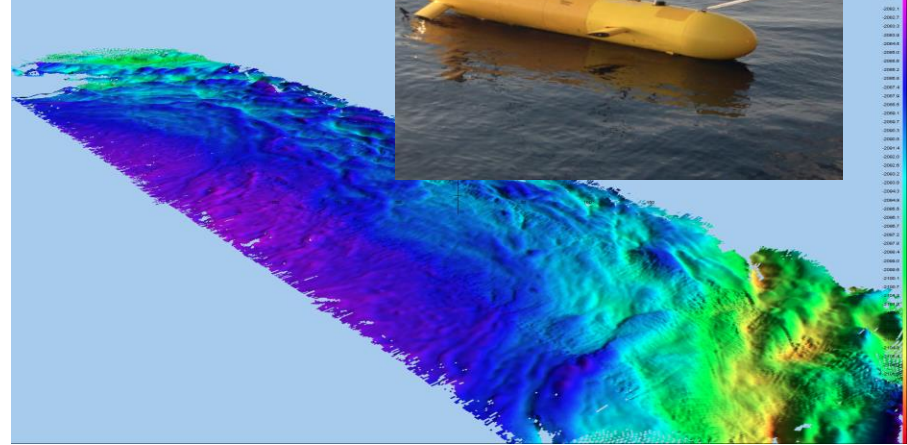

- A remotely-operated vessel (ROV, left) and right scan from an Autonomous Underwater Vehicle)



Where are we headed GEs???

- Are we taking this opportunity to enrich the profession?
- Sense of ownership, “we own”, of these technologies for our profession
 - We are deeply rooted in measurement of the earth in different scales
 - We know which solution to use for different requirements
- Do we need to become manager of spatial data, as a whole, not just land management?

- Context and background of the talk
- Historical highlights: from past to present
- Future vision and directions
- Where are we now? Where are we headed
- Academic curriculum of GE
 - Anticipating the trends
- Take Home Message

UP Department Geodetic Engineering Academic Curriculum

Answer to the challenges of the times

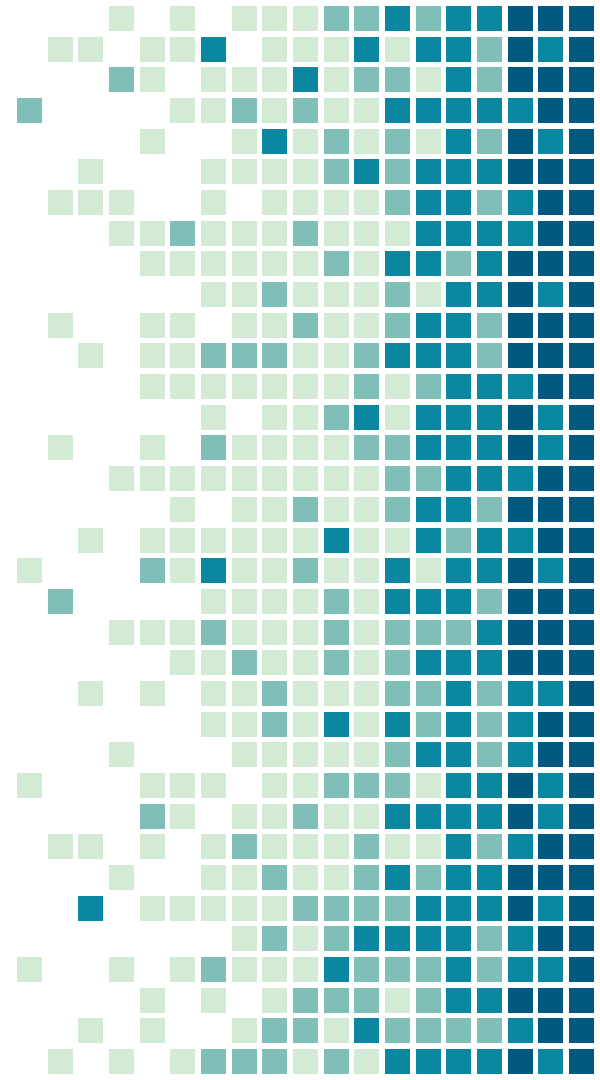

DGE Profile

AY 2016-2017



- Established in June 1937
- Offers BSGE, MS Geomatics Engg, Training Courses
- Faculty: 18 Full-time Regular; 6-8 Lecturers
 - Regular: 4 PhD, 10 MS, 4 BS
 - 2 Profs, 1 Assoc. Profs., 11 Asst. Profs., 4 Instructors
- Students
 - BSGE: > 450
 - MSGmE: >50
- CHED Center of Excellence (2000-2006), (2015-2017)
- GE Board topnotchers; 100% passing most of the time



Faculty

- 4 PhD, 10 MSc, 4 BS, 6-8 lecturers
 - 3 doing PhD (UTwente, UNSW, UTokyo)
 - 3 doing MS (UPD, UTokyo)
- Organized into following committees: ExtAC, IntAC, StAC, AcadProC, TCCom





FACULTY DEVELOPMENT

- Centre for Space Science and Technology Education in Asia and the Pacific (India, UN)
 - Remote sensing (SAR)
- KARI (Korea)
 - Space Technology
- TUMST (Japan)
 - GNSS
- UNU (Japan)
- UTwente (Netherlands)
- Line-up for PhD studies abroad...





DGE Research Laboratories

- Applied Geodesy & Space Technology (**AG&ST**)
- Environmental Systems Applications of Geomatics Engineering (**EnviSAGE**)
- Geo-Simulation Group
- Geodesy, Surveying and Land Administration and Valuation (**GeoSurvLAV**)
- OpenSpaceLab (???)





R&D Projects

- DREAM Program (complete)
- Phil-LiDAR 1 and 2 Programs (complete)
- Project Climate Twin Phoenix - Pablo (completed)
- UP-CCC Natural Resource Assessment (wrapping up)
- UAV project for policy(completed)
- AFAB Project (wrapping up)
- Guiguinto (Phase 1 completed, Phase 2 MOA)
- DA Geoportal Project (Notice to Proceed)
- SRA YESS (ongoing)
- UP-DENR-BMB CoRVA Program (ongoing MSI-led)
- UP-DENR PhilCoMaRS (ongoing MSI-led)
- UP lamBlueCeCam (ongoing)

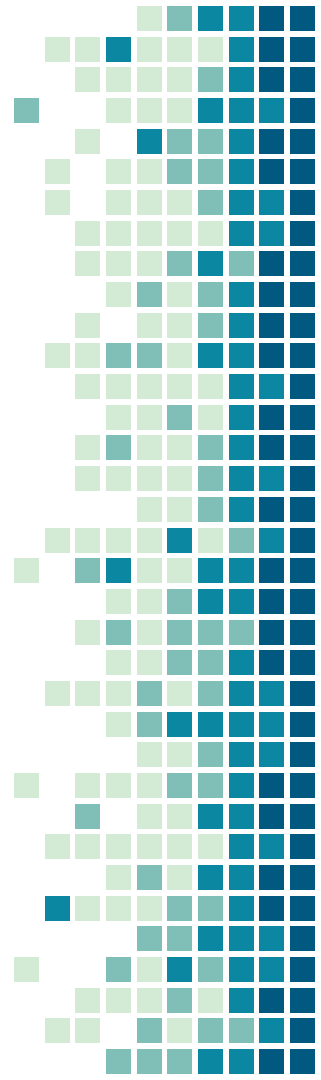



Academic Program

- Currently revising the academic curriculum
 - OBE-dized (outcomes based education)
 - Aiming for ABET and/or washington accordIncorporating the growing demand of Geomatics practitioner.

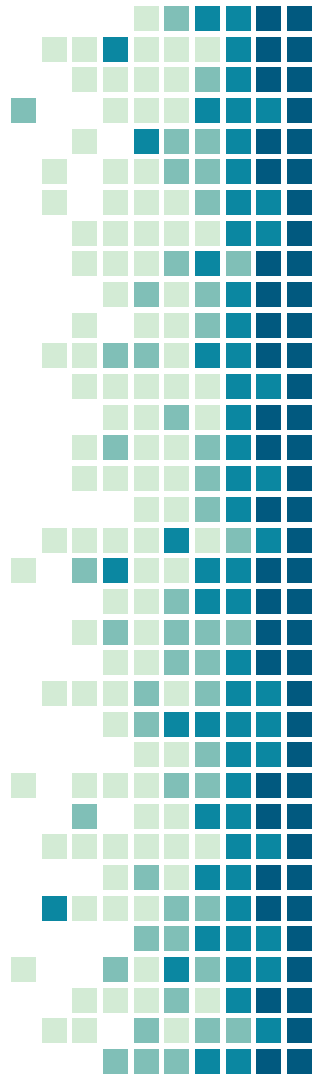



PHILIPPINES - DILIMAN
Bachelor of Science in Geodetic Engineering
FIVE-YEAR CURRICULUM FLOWCHART

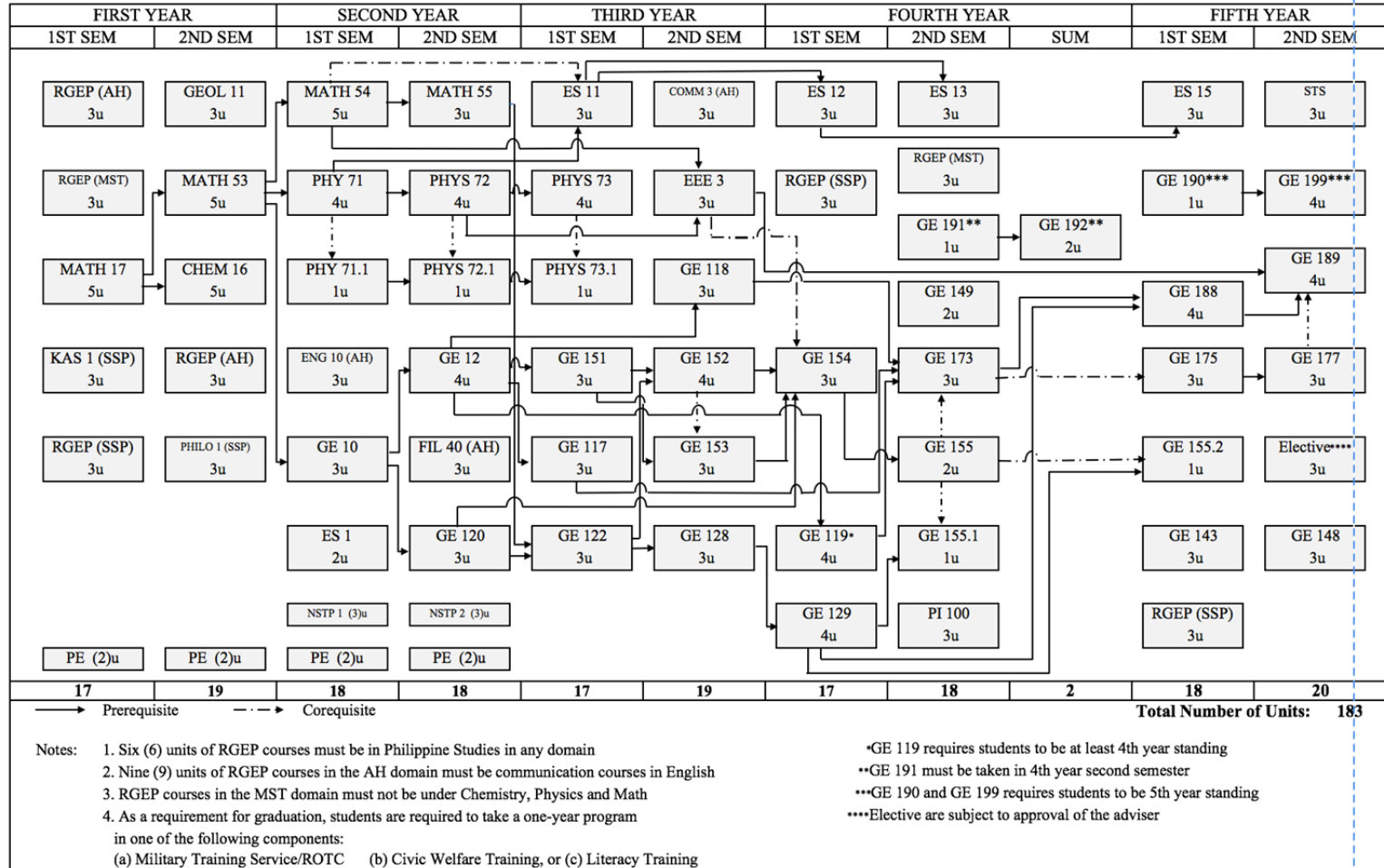

- Notes:
- Six (6) units of RGEP courses must be in Philippine Studies in any domain
 - Nine (9) units of RGEP courses in the AH domain must be communication courses in English
 - RGEP courses in the MST domain must not be under Chemistry, Physics and Math
 - As a requirement for graduation, students are required to take a one-year program in one of the following components:
 (a) Military Training Service/ROTC (b) Civic Welfare Training, or (c) Literacy Training

- *GE 119 requires students to be at least 4th year standing
- **GE 191 must be taken in 4th year second semester
- ***GE 190 and GE 199 requires students to be 5th year standing
- ****Elective are subject to approval of the adviser

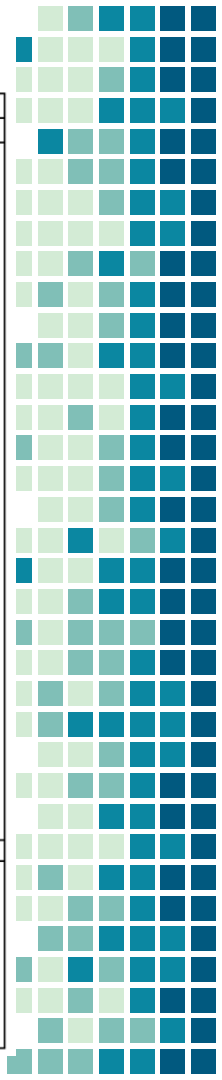

UNIVERSITY OF THE PHILIPPINES DILIMAN
Bachelor of Science in Geodetic Engineering
FOUR-YEAR CURRICULUM FLOWCHART (PROPOSED)

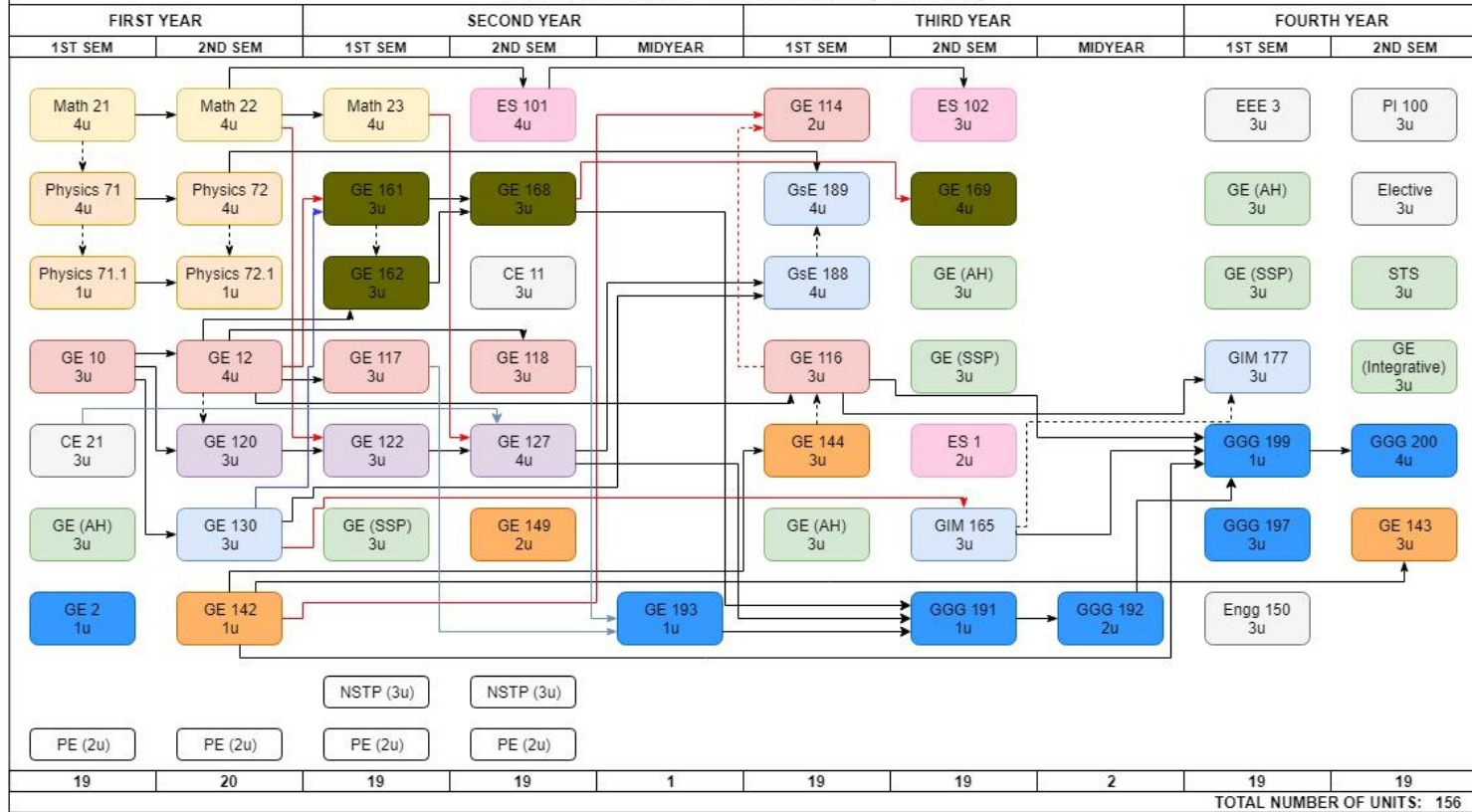

TOTAL NUMBER OF UNITS: 156

→ Prerequisite - - - - -> Co-requisite

Notes:

- GGG 191 requires the student to be at least 3rd year standing.
- 3rd year standing is defined when a student has already taken GE 127, GE 168 and GE 193.
- GGG 199 requires the student to be in senior standing.
- Senior standing is defined when a student has already taken GIM 165, GE 142, GE 116 and GGG 192

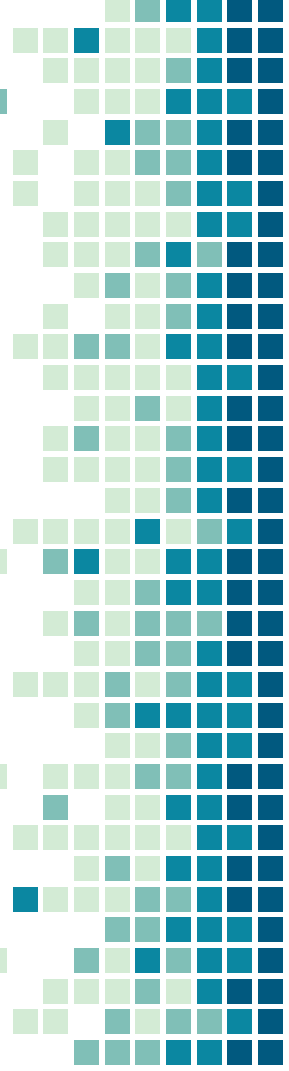



Academic Program

- Currently instituting (proposal) a new academic program – BS GeoInformatics (GIM)

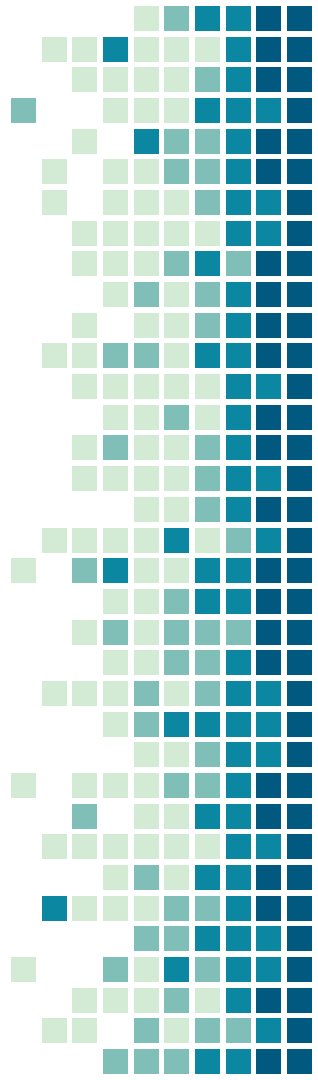



Subjects both in GE and GIM

Course Code and No. (old)	Course Title (old)	# of units (old)	Course Code and No. (new)	Course Title (new)	# of units (new)
GE 10	General Surveying I	3	GE 10	General Surveying I	3
GE 12	General Surveying II	4	GE 12	General Surveying II	3
GE 152	Reference Systems and Reference Frames	4	GE 161	Geometric Geodesy	3
GE 120	Introductory Object-oriented Programming for Geospatial Applications	3	GE 120	Introductory Object-oriented Programming for Geospatial Applications	3
GE 122	Mathematical Methods in Geodetic Engineering	3	GE 122	Mathematical Methods in Geodetic Engineering	3
GE 128	Adjustment Computations for Spatial Data Analysis	3	GE 126	Adjustment Computations for Geospatial Data Analysis	4
GE 173	Digital Cartography	3	GE 173	Digital Cartography	3
GIM 175	Geographic Information Systems: Theory and Applications	3	GIM 175	Geographic Information Systems: Theory and Applications	3
GsE 188	Modern Photogrammetry	4	GsE 188	Modern Photogrammetry	4
GsE 189	Remote Sensing: Theory and Applications	4	GsE 189	Remote Sensing: Theory and Applications	4
GIM 177	Land Development and Valuation	3	GIM 177	Land Development and Valuation	3
GE 191	Geodetic and Geospatial Engineering and Geoinformatics Practicum I	1	GE 191 or GGG 191	Geodetic and Geospatial Engineering and Geoinformatics Practicum I	1
GE 192	Geodetic and Geospatial Engineering and Geoinformatics Practicum II	2	GE 192 or GGG 192	Geodetic and Geospatial Engineering and Geoinformatics Practicum II	2
GE 190	Seminar in Geodetic and Geospatial Engineering and Geoinformatics	1	GE 190 or GGG 190	Seminar in Geodetic and Geospatial Engineering and Geoinformatics	1
GE 199	Undergraduate Research	4	GE 199 or GGG 199	Undergraduate Research	4
			GE 197 or GGG 197	Special Topics	3
				TOTAL	47





Subjects unique in GIM

Course Code and No. (new)	Course Title (new)	# of units (new)
to be determined	Spatial Statistics	3
	Spatial Databases	3
	Geovisualization	3
	3D GIS	3
	Advanced Object-oriented Programming and Data Structures for Geospatial Applications	3
	Land Information Systems	3
	Geospatial Decision Support Systems	3
	Spatial Data Quality, Standards and Infrastructure	2
	Geospatial Data Analysis, Modelling and Simulation	4
	Web GIS	3
	Systems Analysis and Design	2
	Law course on ICT	2
	TOTAL	34





Graduate Program

- MS Geomatics
 - Specialization in Remote Sensing
 - Specialization in GeoInformatics
 - Specialization in Geodesy



- Context and background of the talk
- Historical highlights: from past to present
- Future vision and directions
- Where are we now? Where are we headed
- Academic curriculum of GE
 - Anticipating the trends
- Take Home Message

Take Home Message

My opinion on the challenges of GE

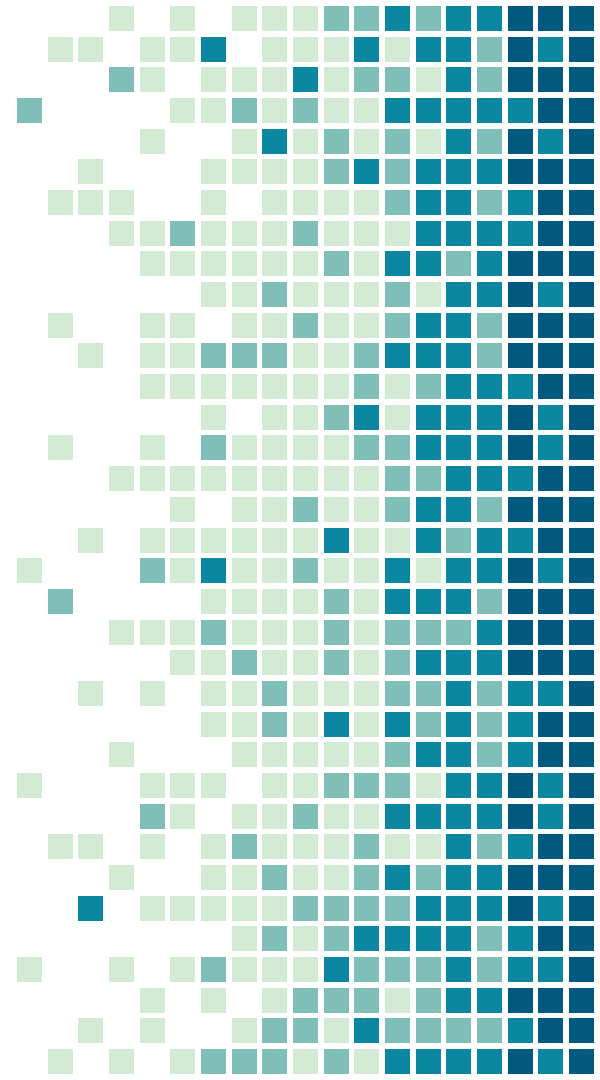

Take Home Message

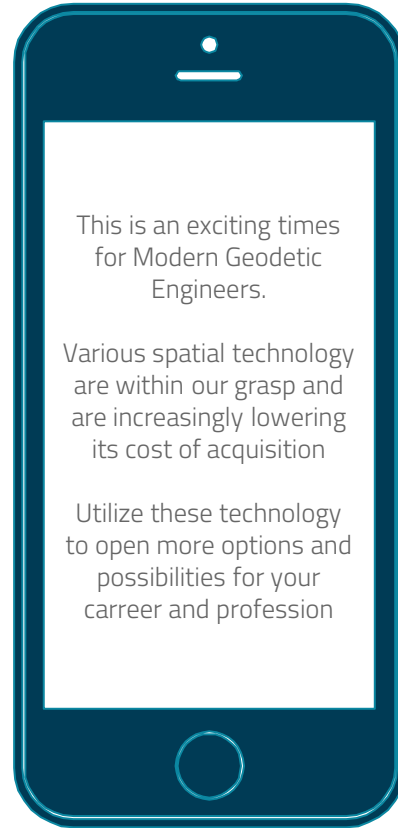

Take Home Message

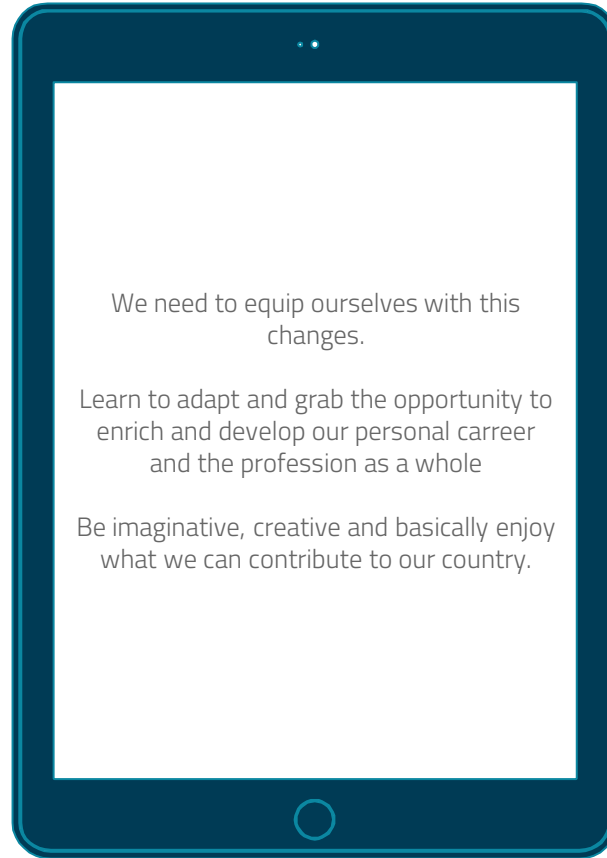

Take Home Message

Do not stop studying and opening yourself to new knowledge.

Learn to be multidisciplinary. GE is not just land surveys
nowadays

Continue developing yourself through CPE, short courses,
trainings, masteral and graduate studies

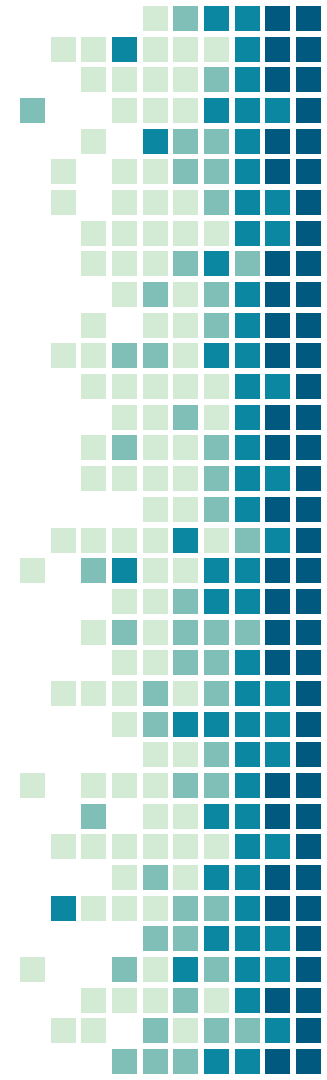

THANKS!

“A good scientist is a person with original ideas. A good engineer is a person who makes a design that works with as few ideas as possible. There are no prima donnas in engineering.”

— [Freeman Dyson](#)